

INSTRUCTION MANUAL

Serial Number _____

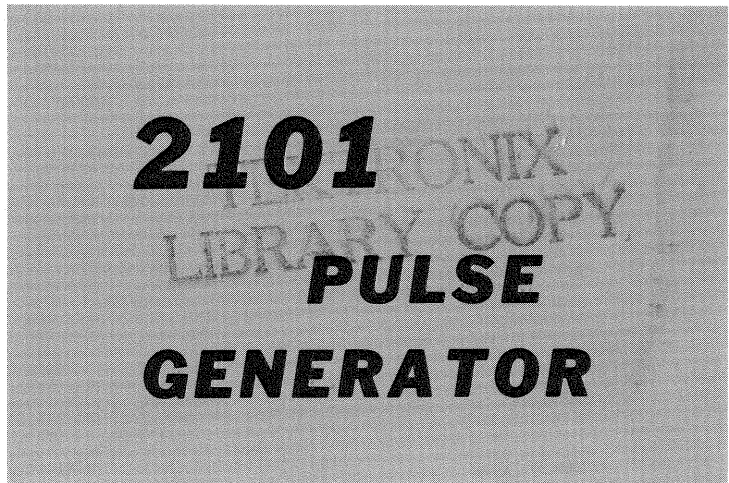



WARRANTY

All Tektronix instruments are warranted against defective materials and workmanship for one year. Tektronix transformers, manufactured in our plant, are warranted for the life of the instrument.

Any questions with respect to the warranty mentioned above should be taken up with your Tektronix Field Engineer.

Tektronix repair and replacement-part service is geared directly to the field, therefore all requests for repairs and replacement parts should be directed to the Tektronix Field Office or representative in your area. This procedure will assure you the fastest possible service. Please include the instrument Type and Serial or Model Number with all requests for parts or service.

Specifications and price change privileges reserved.

Copyright© 1970 by Tektronix, Inc., Beaverton, Oregon. Printed in the United States of America. All rights reserved. Contents of this publication may not be reproduced in any form without permission of the copyright owner.

TABLE OF CONTENTS

SECTION 1 SPECIFICATION

Introduction	1-1
General Description	1-1
Performance Conditions	1-1
Electrical Characteristics	1-1
Output Pulse Characteristics	1-1
Input Requirements	1-2
Power Requirements	1-2
Environmental Characteristics	1-2
Physical Characteristics	1-2
Dimensions	1-2
Weight	1-2

SECTION 2 OPERATING INSTRUCTIONS

Introduction	2-1
Installation	2-1
Controls and Connectors	2-3
Familiarization	2-3
First Time Operation	2-4
Definition of Pulse Characteristics	2-6
Selecting Pulse Modes and Characteristics	2-6
Triggering and Gating	2-9
Output Pulse Connections	2-10
Impedance Matching	2-10
Use of Two Pulse Generators	2-13
Control Setup Chart	2-13

SECTION 3 CIRCUIT DESCRIPTION

Introduction	3-1
Block Diagram Description	3-1
Detailed Circuit Description	3-5

SECTION 4 MAINTENANCE

Introduction	4-1
Installation of Custom Timing Capacitors	4-1
Preventive Maintenance	4-1
Cleaning	4-1
Lubrication	4-2
Inspection	4-2
Performance Checks	4-2
Troubleshooting	4-2

Corrective Maintenance	4-6
Obtaining Replacement Parts	4-6
Soldering Technique	4-6
Removal and Replacement of Subassemblies and/or Components	4-7
Physical Location of Components	4-9

SECTION 5 PERFORMANCE CHECK/ CALIBRATION

Introduction	5-1
Complete or Partial Performance Check	5-1
Complete or Partial Calibration Procedure	5-1
Test Equipment Required and Recommended	5-1
Short Form Procedure	5-2
Calibration Record	5-2
Index	5-2
Performance Check/Calibration Procedure	5-2
General	5-2
Preliminary Procedure	5-3
Test Equipment Setup and Control Settings	5-4
Check/Adjust Steps	5-4

SECTION 6 ELECTRICAL PARTS LIST

Abbreviations and Symbols
Parts Ordering Information
Index of Electrical Parts List
Electrical Parts List

SECTION 7 DIAGRAMS AND MECHANICAL PARTS ILLUSTRATIONS OF

Electrical
Mechanical
Accessories
Repackaging

SECTION 8 MECHANICAL PARTS LIST

Mechanical Parts List Information
Index of Mechanical Parts Illustrations
Mechanical Parts List
Accessories

Abbreviations and symbols used in this manual are based on or taken directly from IEEE Standard 260 "Standard Symbols for Units", MIL-STD-12B and other standards of the electronics industry. Change information, if any, is located at the rear of this manual.



Fig. 1-1. 2101 Pulse Generator.

SECTION 1

SPECIFICATION

Change information, if any, affecting this section will be found at the rear of the manual.

Introduction

The 2101 is a 25 MHz, 10 volt general purpose pulse generator with simultaneous positive and negative-going output pulses. Pulse risetime and falltime is 5 ns or less. Pulse amplitude and baseline offset of the two outputs can be controlled separately. Calibrated or variable selection of the pulse period, duration, and delay are made with calibrated and variable controls with a selector position provided for specific pulse characteristics. Pulse modes include: undelayed, delayed, paired (undelayed followed by delayed) and output latched on (DC output equal to the combined pulse amplitude and baseline offset values). Provisions for externally triggering the pulse generator are provided or an external gate pulse may be used to gate the pulse generator on. Associated test equipment can be pre-triggered prior to the generator output pulse, to establish a time reference for all pulse modes.

The instrument is provided with an attached three-wire power cord with a three-terminal polarized plug to connect to the power source. The third wire is directly connected to the instrument frame to ground the instrument for protection of operating personnel, as recommended by national and international safety codes.

The instrument should be operated from a power source with its neutral at or near ground (earth) potential. It is not intended for operation from two phases of a multiphase system, or across the legs of a single-phase three-wire system.

Performance Conditions

The specified limits of the instrument characteristics are valid with the following conditions:

The instrument must have been calibrated within an ambient temperature of 20°C to 30°C. (Section 5 provides a description of the procedure for checking and calibrating the 2101.) The instrument must be operated within an ambient temperature of 0°C to 50°C and the instrument must be allowed to warm up for 30 minutes after turning on the POWER switch.

ELECTRICAL CHARACTERISTICS



Pulse Outputs

Characteristic	Performance
Pulse Period	40 ns to 40 ms in decade steps when the VARIABLE control is in calibrated position. Continuously variable between calibrated steps. PERIOD VARIABLE extends maximum period to at least .4 s.

Characteristic	Performance
Accuracy	Within 5% of PERIOD selector indication plus 3 ns. PERIOD VARIABLE at the 1× position.
Pulse Duration	20 ns to .2 s in decade steps when VARIABLE control is in calibrated position. Continuously variable between calibrated steps. DURATION VARIABLE extends maximum duration to at least 4 s with manual or external trigger.
Accuracy	Within 5% of DURATION selector indication plus 3 ns. DURATION VARIABLE at 1× position.
Maximum Duty Factor (Duty Cycle)	Maximum duty factor is 80% or more when pulse period is 100 ns or more.
Ratio of Pulse Duration/Pulse Period	Duty factor decreases to 50% at a pulse period of 40 ns. Minimum pulse separation is 20 ns.
Pulse Delay	20 ns to 200 ms in decade steps when VARIABLE control is in calibrated position. Continuously variable between steps. DELAY VARIABLE extends delay to at least 4 s (20:1 range) with manual or external trigger.
Accuracy	Within 5% of DELAY selector indication plus 3 ns. DELAY VARIABLE in 1× position.
Paired Pulse Minimum Separation ¹	20 ns or 20% of pulse duration, whichever is greater.
Pulse Risetime (10% to 90% amplitude levels)	5 ns or less
Preshoot (Preshoot time interval is 5 ns prior to 10% amplitude point.)	3% or less of pulse amplitude, or 30 mV, whichever is greater.
Overshoot and Ringing: (Time interval is 5 ns after 90% amplitude point.)	+3%, -3%; total not to exceed 3% of pulse amplitude, or 100 mV, whichever is greater.
Pulse Falltime (90% to 10% amplitude levels)	5 ns or less
Preshoot (Time Interval 5 ns prior to 90% amplitude point.)	3% or less of pulse amplitude, or 30 mV, whichever is greater.

¹Separation is the time interval between the trailing edge of the first pulse to the leading edge of the second pulse.

Specification—2101

Characteristic	Performance
Overshoot and ringing. (Time interval 5 ns after 10% amplitude point.)	+3%, -3%; total not to exceed 3% of amplitude, or 100 mV, whichever is greater.
Pulse Top Flatness, Slope or Tilt. (Time interval is 5 ns after 90% amplitude point at the leading edge, to 5 ns before 90% amplitude level at the trailing edge.)	Within 3% of pulse amplitude.
Baseline Flatness. (Baseline flatness time interval is 5 ns after 10% amplitude level of the trailing edge to 5 ns prior to leading edge 10% amplitude level.)	Within 3% of pulse amplitude.
Source Resistance. 50 Ω INTERNAL TERMINATION in.	Within 5% of 50 Ω.
Pulse Amplitude. (Peak pulse excursion, excluding aberrations, from the baseline midpoint to pulse duration midpoint, see Fig. 1-2). With 50 Ω INTERNAL TERMINATION out.	Output pulse voltage range is 200 mV or less to within +5%, -2% of 10 volts peak, into 50 Ω load. Current output is 4 mA or less to 200 mA +5%, -2%.
With 50 Ω INTERNAL TERMINATION in.	Output pulse voltage range is 100 mV or less to within 10% of 5 volts, into 50 Ω load.
Amplitude Stability	Within 2% of pulse amplitude for any 1 hour interval after initial warmup.
Amplitude Change with Duty Factor	4% or less of average pulse amplitude, from minimum to maximum duty factor.
Pulse Coincidence (+ and - Outputs)	Leading edge of pulse outputs within 2 ns of each other. Measured at 50% amplitude point.
Baseline Offset Range (50 Ω INTERNAL TERMINATION Out)	Positive or negative-going current to 40 mA or more. This provides a maximum offset, into 50 Ω load, of (+ and -) 2 volts or more.
Range (50 Ω INTERNAL TERMINATION In)	Offset range (+ and -) 1 volt or more, into 50 Ω load.
Output Voltage Limit (50 Ω INTERNAL TERMINATION out)	
 OUTPUT	Between +21 V and -21 V
 OUTPUT	Between -21 V and +7 V

Characteristic	Performance
PRETRIG Output Amplitude Occurance	1 volt or more into 50 Ω load. 20 ns or more prior to undelayed pulse output.

Input Signals

External Trigger Amplitude	+1 volt minimum to +3 volts maximum.
Maximum Safe Input Level	5 volts (DC + peak AC)
Delay to Output	60 ns or less, UNLDY'D mode.
Reset Level	+50 mV or less
Minimum on Time	20 ns (50% amplitude points)
Minimum Off Time	20 ns (50% amplitude points)
External Gate Input Amplitude	+1 volt minimum to +3 volts maximum.
Maximum Safe Input Level	5 volts (DC + peak AC)
Reset Level	+50 mV or less.
Delay to Output (Undelayed Mode)	60 ns or less
Minimum On Time	20 ns (50% amplitude point)
Minimum Off Time	20 ns (50% amplitude point)

POWER INPUT REQUIREMENTS

Line Voltage (RMS)	
115 V Range (LO)	90 V to 110 V
(M)	104 V to 126 V
(HI)	112 V to 136 V
230 V Range (LO)	180 V to 220 V
(M)	208 V to 252 V
(HI)	224 V to 272 V
Crest Factor (Ratio: Peak/RMS)	At least 1.3
Line Current	0.6 A maximum
Power	55 W maximum at 115 V, 60 Hz
Line Frequency Range	48 Hz to 440 Hz
Fuse (Line) (230 V)	0.6 A slow blow 0.4 A slow blow

ENVIRONMENTAL CHARACTERISTICS

Temperature Operating Non-Operating	0°C to 50°C Ambient -40°C to 65°C
Altitude Operating Non-Operating	To 15,000 feet To 50,000 feet

PHYSICAL

Finish	Front panel is anodized aluminum
Weight (net)	Approximately 8.8 lbs.
Dimensions (overall)	Approximately 14 ³ / ₄ inches by 8 inches by 4 ⁵ / ₁₆ inches. See Fig. 1-3.

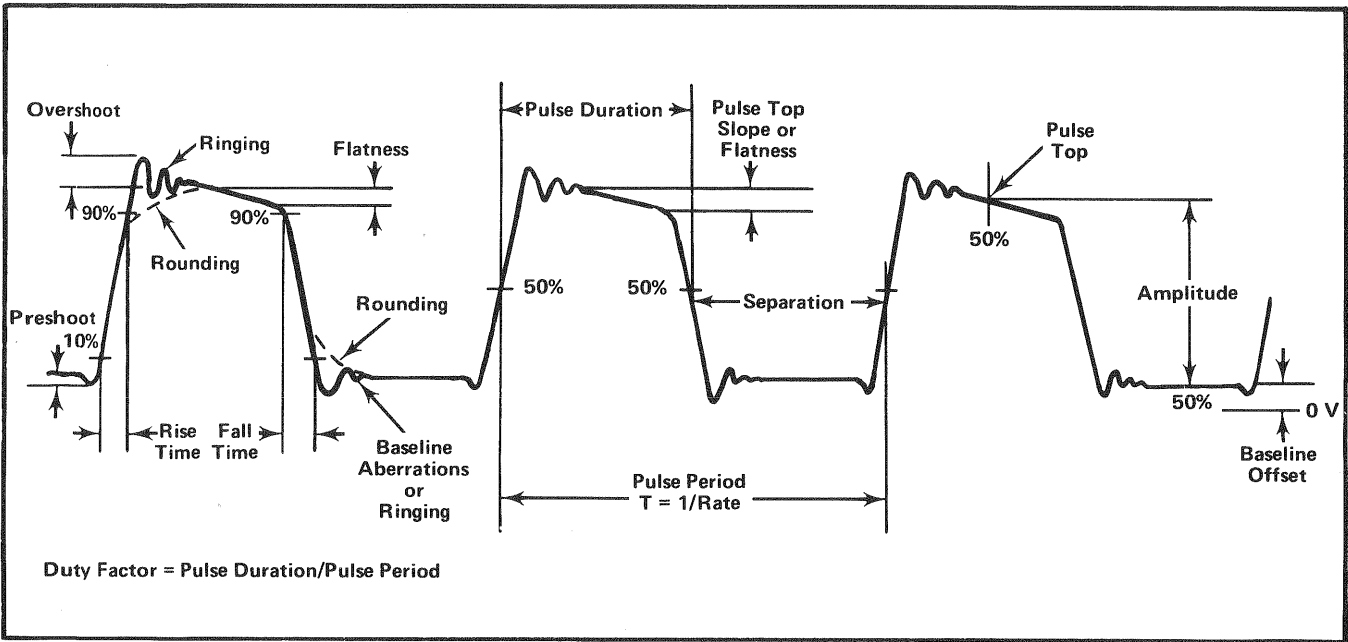

Fig. 1-2. Primary pulse characteristics illustrated.

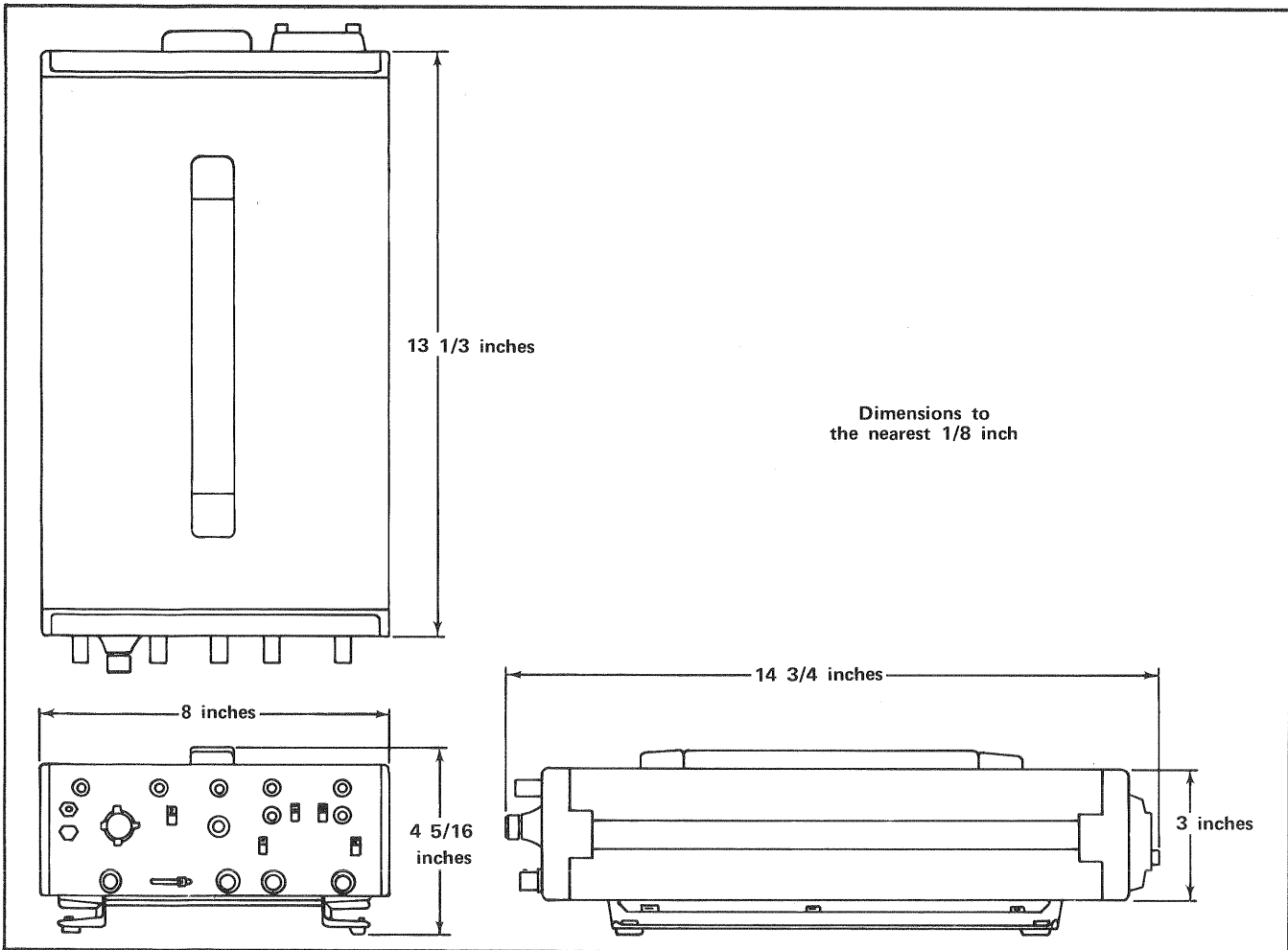

Fig. 1-3. Approximate physical dimensions of 2101.

SECTION 2

OPERATING INSTRUCTIONS

Change information, if any, affecting this section will be found at the rear of the manual.

Introduction

This section of the manual describes instrument operation and basic applications. It covers installation procedure, a glossary of pulse terms that are used in this manual, a description and function of each control and connector, first time operating procedure, and some basic applications for the instrument.

Installation

The 2101 is provided with an attached three-wire power cord with a three terminal polarized plug for connecting to the power source. The third wire is directly connected to the instrument frame and is intended to ground the instrument to protect operating personnel, as recommended by the national and international safety codes. Color coding of cord conductors follows the National Electrical Code: Line conductor—black, neutral conductor—white, safety earth (grounding) conductor—green.

The instrument is intended to be operated from a single-phase power source which has one of its current-carrying conductors (the neutral conductor) at or near ground (earth) potential. Operation from other power sources, where both current-carrying conductors are live with respect to ground (such as phase-to-phase on a multi-phase system, or across the legs of a 117-134 V single-phase three-wire system), is not recommended. Only the line conductor (black wire) has over-current (fuse) protection within the instrument.

Line voltage range for the 115 V selector position is 90 V to 136 V (not to exceed 177 V); and 180 V to 272 V (not to exceed 352 V) for the 230 V selector position. See Table 2-1. Line frequency range is 48 Hz to 440 Hz.

TABLE 2-1
REGULATING RANGES

Voltage Selector Switch Position	Line Voltage	
	90-136	180-272
LO (Switch bar in left holes)	90 to 110 volts	180 to 220 volts
M (Switch bar in middle holes)	104 to 126 volts	208 to 252 volts
HI (Switch bar in right holes)	112 to 136 volts	224 to 272 volts

The line voltage range (90 V to 136 V or 180 V to 272 V) is divided into three regulating ranges, LO, MED and HI, as shown in Table 2-1 and on the cover plate for the Line Voltage Selector. The Line Voltage selector assembly on the rear panel selects the power transformer turns ratio for the power line voltage. The correct fuse protection is also se-

lected. Select the line voltage regulating range for your power source as follows:

1. Loosen the two captive screws that hold the Voltage Selector cover in place and pull to remove the cover.

2. If the voltage selector must be changed, from either 115-volt to 230-volt or 230-volt to 115-volt nominal line voltage, pull out the Voltage Selector bar (Fig. 2-1) turn it 180° and plug it back into the holes provided. Change the line-cord power plug to match the power source receptacle or use a 115-to-230-volt adapter.

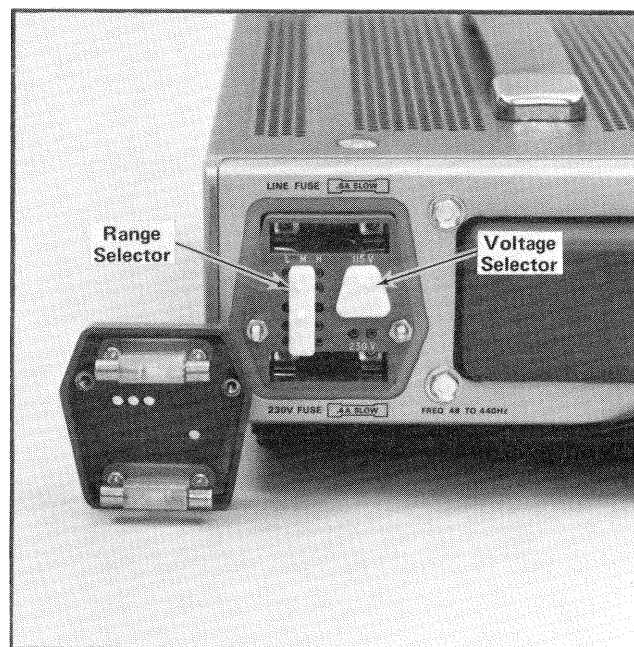

Fig. 2-1. Line Voltage Selector assembly on the rear panel (shown with the cover removed).

3. Pull out the Range Selector bar (Fig. 2-1) and re-insert it in one of the three positions that covers the line voltage range of the source to which the instrument will be connected.

4. Replace the cover to the Line Voltage Selector assembly and tighten the captive screws.

5. Check the indicating tabs on the switch bars to insure that they protrude through the correct holes in the Voltage Selector cover for the desired voltage regulating range; then plug the power cord into the power source and turn the POWER switch on. Allow 30 minutes for the instrument to stabilize.

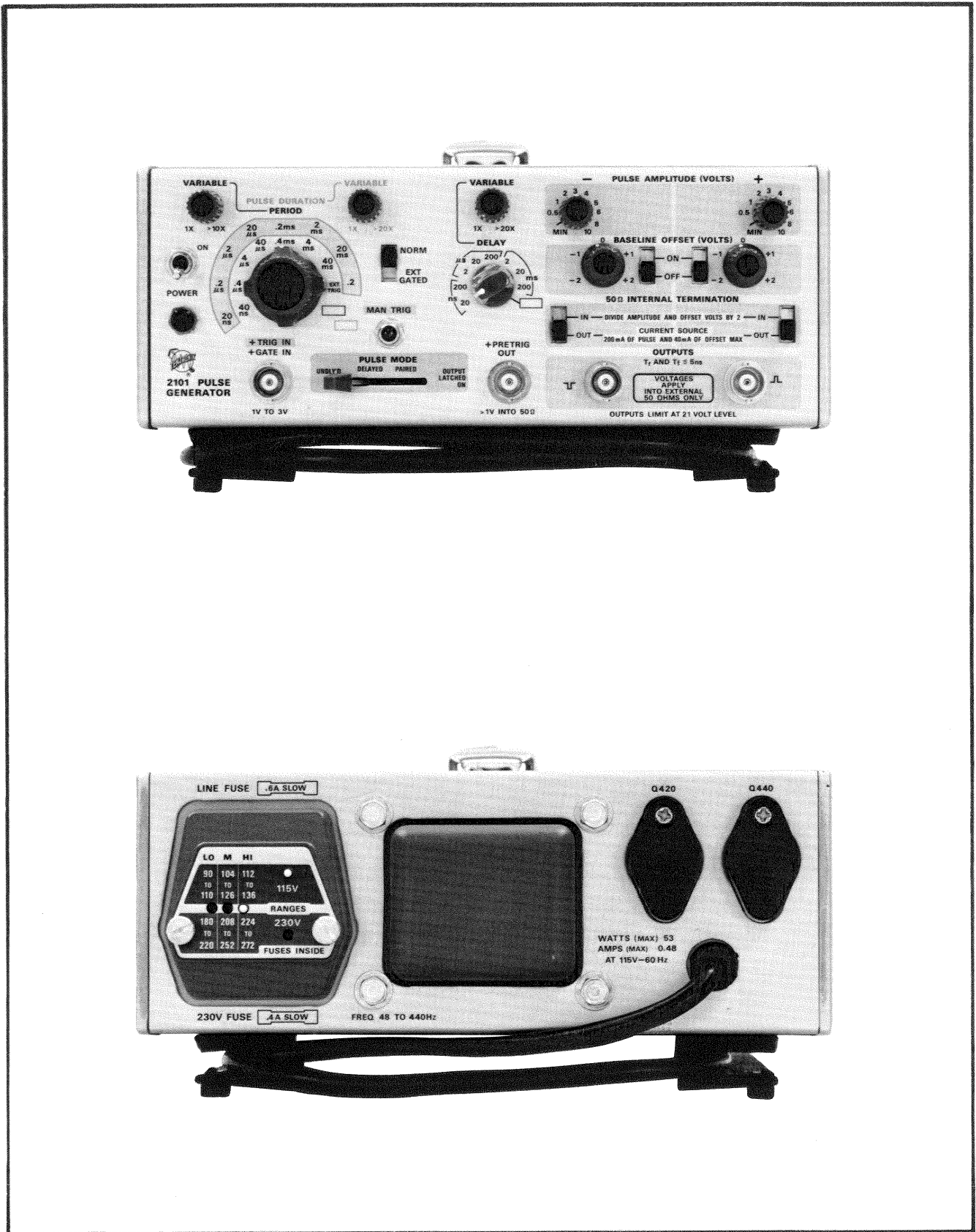

Fig. 2-2. Front and rear panel controls and connectors.

The ambient temperature range or the operating environment for the instrument should be between 0° C (32° F) to 50° C (122° F). A thermal cutout in the instrument provides thermal protection if the internal temperature exceeds a safe operating level. Power is automatically restored when the temperature decreases to a safe level.

CONTROLS AND CONNECTORS

The following describes the function and operation of the controls and connectors on the front and rear panel. Fig. 2-2 illustrates their location. A more detailed description is provided later in this section under general operating considerations.

PULSE MODE Switch Selects the following pulse output modes (illustrated in Fig. 2-4):
 UNDLY'D—Undelayed pulse generation. Delay controls are bypassed.

DELAYED—Pulse output is delayed for some time interval after the undelayed signal. Delay time is selected and set by the DELAY controls. (Delay interval is the time from the leading edge of the undelayed pulse to the leading edge of the delayed pulse.)

PAIRED—Combines the undelayed and delayed modes. Initial pulse occurs with no delay followed by the second or delayed pulse.

OUTPUT LATCHED ON—Latches the OUTPUT to a DC level set and controlled by the PULSE AMPLITUDE and BASELINE OFFSET controls.

NORM-EXT GATED Switch Selects two operational modes:
 NORMAL—Pulse characteristics are dependent on the 2101 PERIOD, DURATION, and PULSE MODE selections.

EXT GATED—Pulse output is gated by an external positive input gate pulse. Provides a burst of output pulses for the applied gate duration. The characteristics of these pulses within the gated interval are established by the MODE, DURATION, and DELAY controls. The period of the pulses within the burst is a function of the PERIOD selection. Last pulse in the burst is not shortened or cut off at the end of the gate interval.

PERIOD Selector Selects calibrated pulse periods and external trigger for the pulse generator. Pulse period selections are calibrated in decade steps from 40 ns to 40 ms. An added position permits the operator to select a unique period within the calibrated range of the PERIOD selector. It may be used to extend the period more than 40 ms if desired. (Internal user-supplied capacitor required. See Maintenance section for installation instructions.) The PERIOD selector is mechanically coupled to the PULSE

DURATION selector so the period remains greater than the pulse duration, for calibrated modes (VARIABLE control in the 1X position).

VARIABLE Control Provides continuous adjustment of pulse period. Varies the pulse period at least 10:1 between calibrated steps.

PULSE DURATION Selects the pulse duration (width). Selections are calibrated in decade steps from 20 ns to .2 s. Pulse duration can be extended to 4 s when an external trigger signal is used. An added position permits the user to select a unique duration within the calibrated range of the PULSE DURATION. It may also be used to extend the duration beyond 0.2 s if a customer-supplied timing capacitor is used. (See Custom Capacitor Installation in the Maintenance Section.) The DURATION selector is mechanically coupled with the PERIOD selector so the pulse duration is less than the pulse period when both are operated in the calibrated mode.

VARIABLE Control Provides a continuous adjustment of pulse duration. Control range is at least 20:1 between calibrated steps. Will also extend the pulse duration to more than 4 s when an external trigger signal is used.

DELAY Selector Selects delay period of the output pulse. Selections are calibrated in decade steps from 20 ns to 200 ms. An added position permits the user to select a unique delay period within the calibrated range of the DELAY selector. It may also be used to extend the delay period more than 200 ms if a customer supplied capacitor is used.

VARIABLE Control Provides continuous adjustment of the pulse delay. Range of the control is at least 20:1 between calibrated steps. Can extend the delay period to more than 4 s when the 2101 is externally or manually triggered.

**+ TRIG IN
 + GATE IN Connector** Setting the PERIOD selector to EXT TRIG position and the NORM-EXT GATED switch in the NORM position permits external triggering of the period generator. An applied positive trigger signal (amplitude between 1 V and 3 V) will trigger one pulse cycle out of the period generator. Switching the NORM-EXT GATED switch to the EXT GATED position provides gated or burst pulse output operation. An applied external DC-coupled positive gate signal (amplitude between 1 V and 3 V) will enable the pulse period generator for the duration of the input gate. Output burst starts within 60 ns (UNDLY'D Mode) after the input gate amplitude exceeds +50 mV level (above chassis ground) and continues until gate drops below +50 mV

level. The last pulse is not cut off or shortened when the input gate ends. Input resistance at the connector is about 200 Ω. Maximum input frequency is 25 MHz.





MAN TRIG—With PERIOD selector in the EXT TRIG position and the NORM-EXT GATED switch in the NORM position, the period generator is manually triggered when this button is depressed.

+PRETRIG OUT—Provides a positive-going output pulse, equal to or greater than 1 V into 50 Ω. This pulse occurs at least 20 ns (typically 40 ns) prior to the undelayed pulse output. Useful for pretriggering an external device such as an oscilloscope.

PULSE AMPLITUDE Controls—These two controls provide independent adjustment of the positive-going (+) and negative-going (−) output pulse amplitude. They also control the DC level at the OUTPUT connectors when the PULSE MODE selector is in the OUTPUT LATCHED ON position. Controls are continuously variable and indicate approximate pulse amplitude across an external load impedance of 50 Ω, with the 50 Ω INTERNAL TERMINATION switch in the OUT position. Divide indicated level by two for load impedance of 25 Ω (50 Ω external load and 50 Ω INTERNAL TERMINATION switch to the IN position).

BASELINE OFFSET Controls—These two controls provide (with the OFFSET switch ON) independent adjustment of the output baseline level around zero volts. Controls are continuously variable and indicate the approximate voltage level for external loads of 50 Ω, with 50 Ω INTERNAL TERMINATION switched to the OUT position.

50 Ω INTERNAL TERMINATION Switches Two switches that switch 50 Ω of back termination resistance into or out of the output circuit. When the back termination is switched IN, the source impedance is 50 Ω; when the back termination is switched OUT, the source impedance increases to approximately 2 kΩ and OUTPUT appears as a current source.

OUTPUT Connectors Provide simultaneous positive-going  and negative-going  pulses with amplitudes, duration, period, and delay, that depend on the controls and selector positions of the pulse-forming and amplifier circuits. Outputs are protected against no load or inductive load conditions. Pulse amplitude limits are:  ±21 V;  −21 V, +7 V.

POWER Selector (Rear Panel) Selects HI, MED, or LO voltage ranges for 115 VAC or 230 VAC line source. It also selects the proper fuse for either of the two ranges.

FIRST TIME OPERATION

This procedure is intended to demonstrate the basic functions of the 2101 controls. It may be used as a general check of the instrument operation. If performance specifications are to be checked refer to Section 5, Performance Check and Calibration Procedure.

1. Set the Line Voltage selectors to the appropriate position for line voltage power source (see Fig. 2-1) and plug the power cord into the source. Turn the POWER switch ON.

2. Apply the + PRETRIG OUT signal through a coaxial cable and 50 Ω termination to the External Trigger Input connector of a test oscilloscope. See Fig. 2-3.

3. Apply the + OUTPUT signal, through a coaxial cable, a 10× 50 Ω attenuator, and a 50 Ω terminator, to the vertical Input of the test oscilloscope (Fig. 2-3).

NOTE

When terminating the output signal, connect the 50 Ω termination at the end of the coaxial cable, farthest from the pulse generator OUTPUT.

(Test oscilloscope for this demonstration is a real time oscilloscope. A sampling oscilloscope system can also be used with slight modifications to control settings.)

4. Set the 2101 and test oscilloscope controls as follows:

	Test Oscilloscope
Time/Div	.1 μs
Volts/Div	.2
Triggering	+ External, Normal
Vertical Input Coupling	DC
	2101
PULSE MODE	UNDLY'D
PERIOD	.4 μs
VARIABLE	Fully CCW
NORM-EXT GATED	NORM
DELAY	20 ns
VARIABLE	Fully CCW
+ PULSE AMPLITUDE	5
+ BASELINE OFFSET	OFF
50 Ω INTERNAL TERMINATION	OUT

5. Adjust the test oscilloscope triggering, positioning and CRT controls to obtain a stable display of the output pulse (see Fig. 2-4).

6. Turn the + PULSE AMPLITUDE (VOLTS) control through its range and note that the pulse amplitude varies from 10 volts to approximately 200 mVolts with little change in the pulse risetime or falltime. Reset the AMPLITUDE to 5 volts.

7. Switch the PULSE MODE to the DELAYED position. Note the delayed display.

8. Change the PERIOD to 4 μs and the DELAY to 200 ns. Note the delay increase to 200 ns.

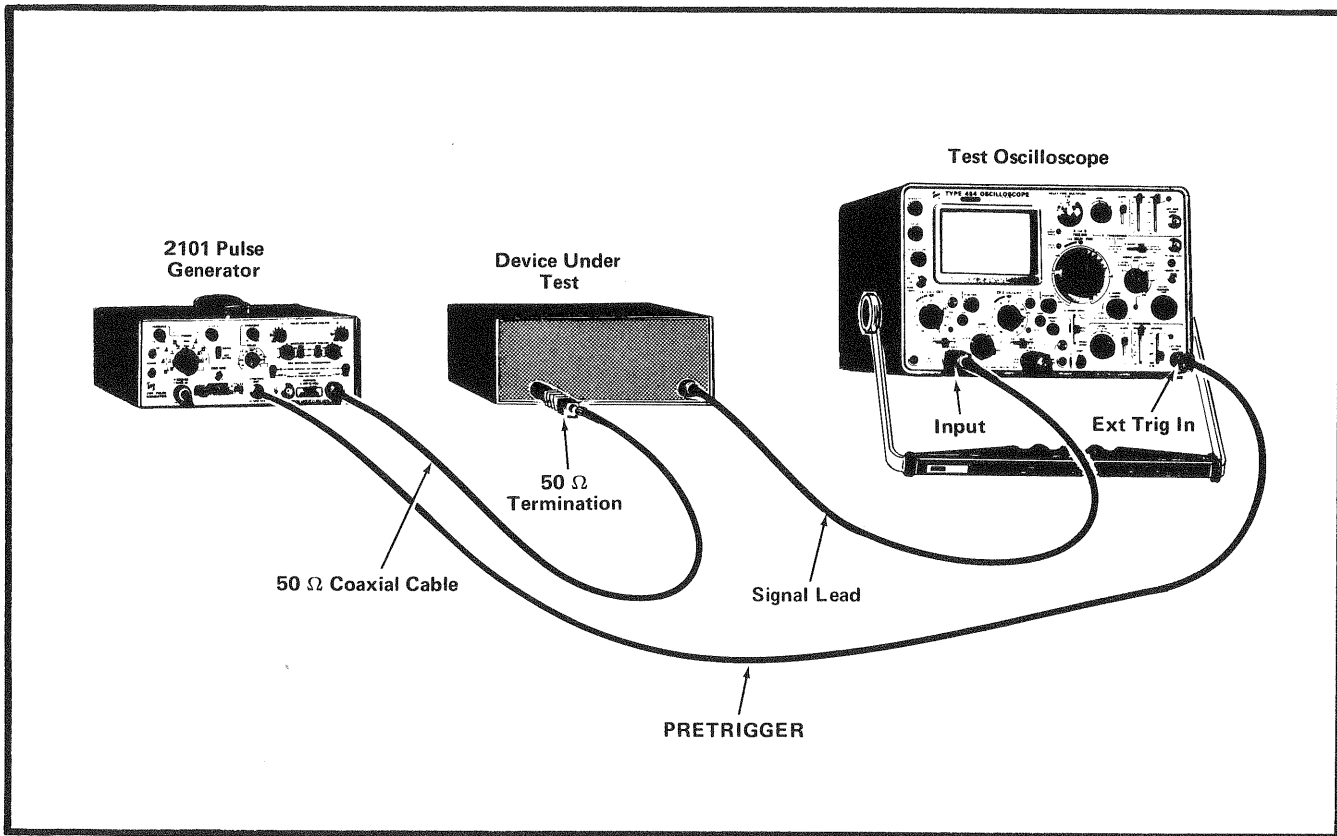

Fig. 2-3. Typical test equipment setup for checking pulse response of a device.

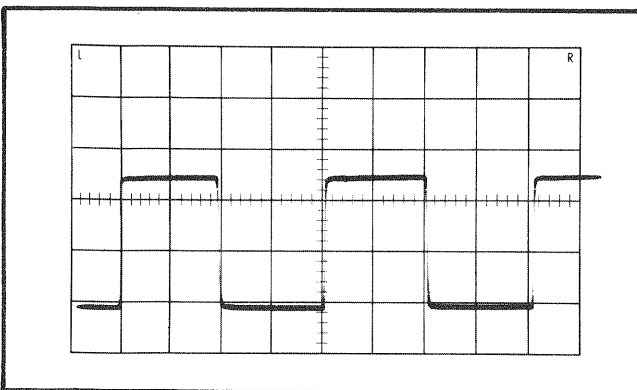

Fig. 2-4. Oscilloscope display of .2 μ s pulse duration, .4 μ s period and 5 V pulse amplitude.

9. Change the PERIOD to 4 ms, the PULSE DURATION to 20 μ s and the test oscilloscope sweep rate to .1 ms. Switch the DELAY from 200 ns to 200 μ s. Note the delay increase in calibrated steps.

10. Delay can be increased to 200 ms, provided the pulse period minus pulse duration exceeds the delay time. This amount of delay will require external triggering.

11. With the DELAY selector in the 200 μ s position, rotate the VARIABLE DELAY control through its range. Note the

delay increase by a factor of 20:1. Return the VARIABLE control to its 1 \times position.

12. Switch the PULSE MODE to PAIRED position, the PULSE DURATION to 20 ns, the PERIOD to 40 μ s, the DELAY to 200 ns, and the sweep rate to .5 μ s/div. Note the undelayed and delayed pulse pairs.

13. Switch the DELAY selector between the 2 μ s and 20 μ s positions. Note the delay interval between paired pulses. Delay should equal the indicated selections of the DELAY selector. Return the DELAY selector to the 20 ns position.

14. Switch the PULSE DURATION to 2 μ s, PERIOD to 40 μ s and Time/Div to 5 μ s. Switch the PULSE MODE selector to OUTPUT LATCHED ON position.

15. The output DC level should now equal the pulse amplitude. Vary the PULSE AMPLITUDE control through its range noting the output DC level vary. Return the PULSE AMPLITUDE control to 5.

16. Switch the + BASELINE OFFSET (VOLTS) to ON and rotate the control through its range. Note the DC level shift +2 volts and -2 volts from its PULSE AMPLITUDE reference. Switch the PULSE MODE back to UNLATCHED position and again note the range of the BASELINE OFFSET control. Return the BASELINE OFFSET switch to the OFF position.

17. Switch the 50 Ω INTERNAL TERMINATION to the IN position. Note the pulse amplitude or DC level decrease by a factor of 2. An internal, back termination of 50 Ω is in-

Operating Instructions—2101

serted between the output amplifier stage and the OUTPUT connector. Source impedance looking into the OUTPUT connector is now $50\ \Omega$. When the $50\ \Omega$ INTERNAL TERMINATION is OFF the OUTPUT connector appears as a current source with an impedance of approximately $2\ \text{k}\Omega$. Return the $50\ \Omega$ INTERNAL TERMINATION to the OFF position.

18. Switch the PERIOD to $40\ \mu\text{s}$ and PULSE DURATION to $2\ \mu\text{s}$. Set the Time/Div to $10\ \mu\text{s}$.

19. Rotate the PERIOD and PULSE DURATION VARIABLE controls through their range. Note their function on the display. Pulse period minus pulse duration must equal or exceed 20 ns or 20% of the pulse duration, whichever is greater. Return the VARIABLE controls to their $1\times$ position.

20. Switch the PERIOD to EXT TRIG and the PULSE DURATION to 20 ms.

21. Depress the MAN TRIG button and note the manual trigger operation. (A 20 ms pulse should be displayed each time the button is depressed.) Return the PERIOD selector to the 40 ms position.

This concludes the basic first time operation and demonstrates the function of the front panel controls.

Definitions of Pulse Characteristics

The following is a glossary of pulse characteristics, used in this manual. They are also illustrated in Fig. 2-6.

Amplitude—The maximum absolute peak value of a pulse, regardless of sign excluding unwanted aberrations or overshoot, from the zero axis. Measured between a point that is 50% of the pulse duration to a baseline reference that is 50% of the off time (pulse period minus pulse duration).

Aberration—Unwanted deviations or excursions in the pulse shape from an ideal square corner and flat top; i.e. overshoot, undershoot or rounding, ringing, and flatness or slope.

Baseline—The quiescent DC voltage reference level, including DC offset, of the pulse waveform.

Burst—A group of pulses within a time interval followed by an interval when no pulses are generated.

Delay Time—The time between the start of the undelayed pulse and the start of the delayed pulse. Measured at the 50% amplitude points.

Duty Factor—Sometimes referred to as duty cycle. The ratio of pulse duration to period or the product of pulse duration and pulse repetition rate. $\text{Duty Factor \%} = \text{Duration/Period} \times 100$.

Falltime—The time interval, at the pulse trailing edge, for the pulse amplitude to fall from the 90% amplitude level to the 10% amplitude level.

Flatness—The absence of long term variations to the pulse top; excluding overshoot, ringing or pulse rounding. Sometimes referred to as tilt or slope.

Overshoot—The short term pulse excursion (or transient) above the pulse top or below the baseline; which is simultaneous to the leading and trailing edge of the pulse.

Period—The timer interval for a full pulse cycle. Inverse of frequency or repetition rate. Interval between corresponding pulse amplitudes of two consecutive undelayed or delayed pulses. Generally measured between the 50% amplitude levels of two consecutive pulses.

Preshoot—A transient excursion which precedes the step function. It may be of the same or opposite polarity as the pulse.

Pulse Duration—The time interval between the leading and trailing edge of a pulse at which the instantaneous amplitude reaches 50% of the peak pulse amplitude.

Pulse Separation—The interval between the same amplitude reference of pulse trailing-edge to the leading-edge of the succeeding pulse. Usually measured between the 50% amplitude points.

Pulse Top—The voltage or current level of the pulse from the baseline.

Polarity—The direction from the baseline of the pulse excursion. Either positive-going (+) or negative-going (—).

Ringing—Periodic aberrations that dampen in time, following the overshoot.

Risetime—The time interval, at the step function leading edge, for the pulse to rise from the 10% to 90% amplitude levels.

Rounding or Undershoot—The rounding of the pulse corners at the edges of a step function.

Tilt or Slope—A distortion of an otherwise flat-topped pulse, characterized by either a decline or a rise of the pulse top. (See flatness).

SELECTING PULSE MODES AND CHARACTERISTICS

A variety of pulse characteristics can be obtained from the 2101 through various combinations of the front panel controls. Undesirable pulse characteristics or no pulse output can also occur if incorrect combinations are used. The following general rules should be kept in mind when setting the front panel selectors for a desired pulse characteristic.

1. The pulse period cannot be less than the sum of the pulse duration ($\times 2$ when in PAIRED Mode), pulse delay, and a 20 ns recovery time or 20% of the pulse duration.

2. In the paired mode, the delay time cannot be less than the pulse duration, plus 20 ns or 20% of the pulse duration (whichever is greater). Minimum delay, with pulse duration of 20 ns, is 20 ns (40 ns when in PAIRED Mode).

3. The OUTPUT must be terminated into a $50\ \Omega$ load or the back termination ($50\ \Omega$ INTERNAL TERMINATION) must

be switched IN to minimize reflections. If the back termination is switched IN and the OUTPUT is not terminated, pulse distortion may occur at output amplitudes of 5-volts or more. See Output Pulse Connections.

4. Accuracies apply only when all VARIABLE controls are in their calibrated (1X) positions.

Pulse Mode

Four pulse modes can be selected with the PULSE MODE selector switch. The undelayed pulse is the reference pulse for each mode. The period, duration, delay, and amplitude

can be set by the front panel controls. In addition; the pulse baseline DC voltage level may be offset by the front panel OFFSET controls. The following describes these modes of operation and Fig. 2-5 illustrates the various modes.

Undelayed Pulse: Identical equally spaced pulses are available at the OUTPUT connectors. Pulse period, duration, and amplitude can be controlled by the front panel controls. Undelayed pulse output occurs after PRETRIG pulse output.

Delayed Pulse: The undelayed pulse is channeled through a calibrated and variable delay circuit. The output has the same characteristics as the undelayed pulse.

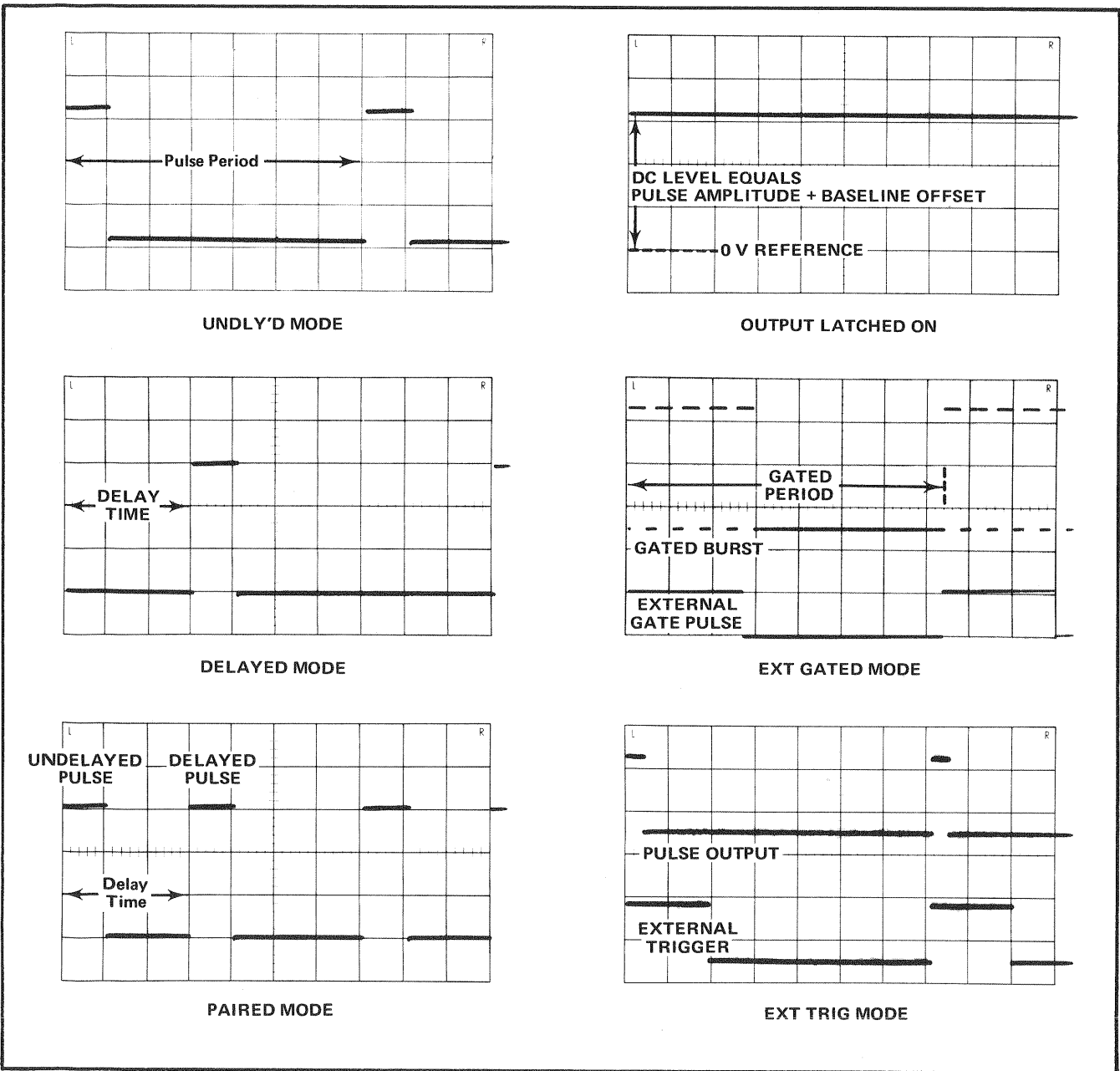

Fig. 2-5. Graphic illustration of 2101 pulse modes.

Operating Instructions—2101

Paired Pulse: The output pulses are grouped into undelayed and delayed pulse pairs. The delayed pulse is referenced to the start of the undelayed pulse. The separation between the trailing edge of the undelayed pulse and the leading edge of the delayed pulse cannot be less than 20 ns or 20% of the pulse duration, whichever is greater. (As the pulse duration increases from 20 ns, the recovery time is longer.) For example: Minimum separation for a pulse duration of 20 ns is 20 ns. Minimum separation for a pulse duration of 1 μ s is 20% of 1 μ s or 200 ns.

Output Latched ON: The output latches to a DC voltage level. This level equals the pulse amplitude plus the DC OFFSET. Output level limits at about ± 21 V for the \square pulse. Minimum separation for a pulse duration of pulse and -21 V, $+7$ for the \square pulse.

Operation Modes

The 2101 has two modes of operation, NORMAL and EXT GATED. In the NORMAL mode the pulse period generator free runs at a rate selected by the PERIOD controls. In the EXT GATED mode the period generator is gated on by an external positive pulse or gate (1 V to 3 V amplitude). This external gate pulse is applied to the + GATE IN connector. The output, when in the EXT GATED mode, is a burst or pulses during the duration of the external gate signal. Characteristics of each pulse within the gated interval depend on the settings of the front panel pulse-forming controls.

External Trigger

When the PERIOD selector is switched to the EXT TRIG position, the period generator is disabled and the pulse forming circuits must be externally triggered by a trigger pulse applied to the + TRIG IN connector. A single pulse can also be obtained, with the PERIOD selector in this position,

by pressing the MANuAl TRIGger pushbutton. This is useful when the operator wishes to increase the pulse period so duration and/or delay can be extended beyond the internal calibrated ranges. For example; pulse duration can be extended to more than 4 s and/or pulse delay extended to more than 4 s with either the DURATION or the DELAY VARIABLE controls. External trigger can also be used for the unique \square setting of the selectors for customer supplied timing capacitors.

When operated in the UNdLY'D mode the output pulse is delayed approximately 40 ns to 60 ns from the input trigger. Maximum frequency for an input trigger pulse is 25 MHz (20 ns minimum off time).

Pulse Period

The pulse period is the time interval for one complete pulse cycle. (See Definitions of Pulse Characteristics and Fig. 2-6.) Pulse period is determined by the PERIOD selector and VARIABLE control positions. The PERIOD selector is calibrated in decade steps from 40 ns to 40 ms. Accuracy of these positions, when the VARIABLE control is in the 1 \times position, is within 5% of the selected position plus 3 ns. The PERIOD VARIABLE control extends the range of the PERIOD selector at least 10:1. The 40 ms position can therefore be extended to .4 s or more.

Pulse Duration

The pulse duration is the time interval between the pulse leading edge and the pulse trailing edge at the 50% amplitude points. (See Definitions of Pulse Characteristics). The pulse duration, for the 2101, is controlled by the DURATION selector and the DURATION VARIABLE control. The DURATION selector is calibrated in decade steps from 20 ns to .2 s when the VARIABLE control is in the 1 \times position. Pulse duration can be extended to 4 s when the pulse period is

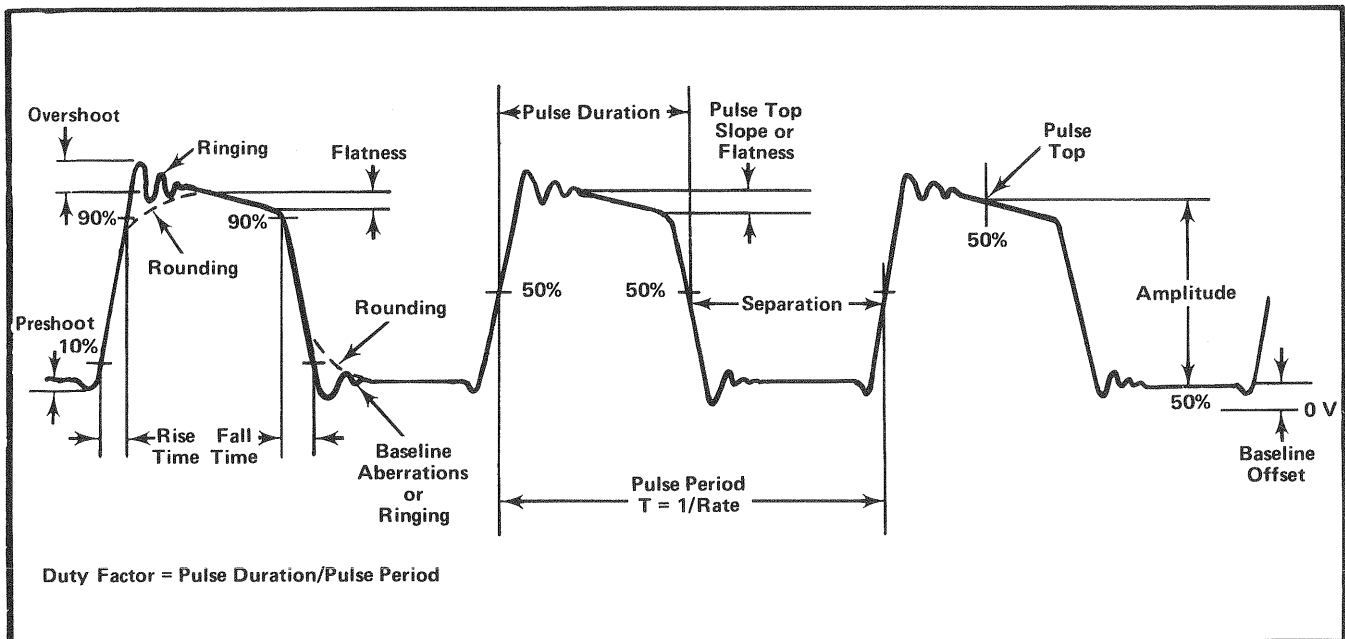



Fig. 2-6. Pulse description in terms of the primary characteristics.

externally triggered, provided the external trigger period is greater than 5 s (pulse duration plus 20% pulse duration). Accuracy, with the DURATION VARIABLE control at the $1\times$ position, is within 5% of the indicated duration plus 3 ns. The DURATION VARIABLE control provides continuously variable pulse duration range between the calibrated steps by extending the range of each selection at least 20:1.

Maximum duty factor (ratio of pulse duration to pulse period) is at least 80% when the period is 100 ns or more. Duty factor decreases to 50% when the period is 40 ns. The PERIOD selector is mechanically coupled to the DURATION selector so the duty factor can not exceed 50% with the VARIABLE controls in the $1\times$ position.

Delay

Delay time is the interval between two corresponding time points of the undelayed and the delayed pulses. The pulse delay is controlled by the DELAY selector and its VARIABLE control. These controls affect the output pulse only when the PULSE MODE selector is in the DELAYED or PAIRED positions. The DELAY selector is calibrated in decade steps from 20 ns to 200 ms. Accuracy when the VARIABLE control is at the $1\times$ position, is within 5% of the indicated position plus 3 ns. The DELAY VARIABLE control provides continuous variable delay between the calibrated steps by extending the delay at least 20:1. The 200 ms position can therefore be extended to at least 4 s. The  position provides a unique user designated delay, within the calibrated range, when a user supplied timing capacitor is installed in the delay circuit (see Installation of Timing Capacitors in Section 4).

The delay time that can be selected, is bracketed by two functions; pulse period and pulse duration. Delay time must equal or exceed the pulse duration plus a minimum of 20 ns recovery time. (The recovery time approaches 20% of the pulse duration for long pulse duration.) The delay time cannot exceed the pulse period minus the recovery time duration (20 ns minimum).

Pretrigger Output

The output pulse, at the PRETRIG OUT connector, is a positive-going pulse that precedes the undelayed pulse by 20 ns or more. The pre-trigger pulse, when used to trigger associated test equipment such as an oscilloscope, provides a time reference for the output pulses from the 2101. The delayed pulse, for example, will move across the CRT display as the DELAY is varied, and the pulse can be referenced to the sweep start or the undelayed pulse. The pretrigger amplitude is constant. This provides stable triggering over all changes in pulse characteristics so that the oscilloscope triggering controls do not have to be readjusted.

The amplitude of the pretrigger pulse is at least 1 volt into 50 Ω . The pulse risetime is approximately 6 ns. Lead time is at least 20 ns prior to the undelayed pulse output.

Pulse Amplitude

Two PULSE AMPLITUDE controls provide independent and continuously variable control of the output pulse amplitude. The pulse amplitude range is 200 mV or less, to 10 volts; into 50 Ω load. PULSE AMPLITUDE control calibration



(MIN—10) is approximate and applicable only when the OUTPUT is terminated into 50 Ω . If the 50 Ω INTERNAL TERMINATION (back termination) is switched IN the pulse amplitude is reduced by half.

The OUTPUT connectors for 2101 appear as a 4 mA or less, to 200 mA, pulse current source when the 50 Ω INTERNAL TERMINATION (back termination) is switched OUT and a 100 mV or less, to 5 volt, 50 Ω source when the 50 Ω INTERNAL TERMINATION is switched IN. Pulse amplitude range is 200 mV or less, to 10 V (within +5%, -2%); into a 50 Ω load, with the back termination switched out, and 100 mV or less, to 5 V (within 10%); into 50 Ω load, with the back termination switched IN. Resistance of the OUTPUT source is approximately 1.5 k Ω with the back termination out and 50 Ω with the termination switched in.

Baseline Offset

The output DC level of the pulse baseline can be independently offset by two BASELINE OFFSET controls. These controls, when the BASELINE OFFSET is switched on, provide continuously variable adjustment (through + and -) of the DC output level. The numbers on the front panel that relate to the controls are approximate voltage levels with the 50 Ω INTERNAL TERMINATION switched OUT. Like the PULSE AMPLITUDE, the output DC level (into 50 Ω load) is reduced by half when the 50 Ω INTERNAL TERMINATION is switched IN.

Current range of the baseline offset circuit, to the output, is at least 40 mA. Current amplitude and direction (out or into) through the external load is controlled by the BASELINE OFFSET controls.

Since the pulse baseline can be offset ± 2 volts, a combined (AC + DC) output of 12 volts (into 50 Ω) is possible. If the output is unterminated, the voltage at the output could swing several volts. A voltage limiter circuit, in the output, limits this swing to plus or minus 21 volts for the  output and minus 21 V, plus 7 V for the  output. This prevents excessive back-voltage swings if the output load should be disconnected.

Baseline stability with DC offset is within 10 mV for any 1 hour period after warmup.

TRIGGERING AND GATING

A variety of triggering options are provided for the UNDL'D, DELAYED, or PAIRED, Pulse Modes; plus a gated pulse mode. The following steps describe these triggering or gating functions.

1. Mode switch in the NORM position.
 - a. The period generator free runs in all PERIOD selector positions except EXT TRIG position. Frequency or period of the output pulses are controlled by the PERIOD selectors.
 - b. Switching the PERIOD selector to the EXT TRIG position, disables the period generator. An external positive-going trigger pulse, or manual trigger operation, is required to trigger the pulse generator. Pulse period depends on the external trigger frequency. Apply the external trigger pulse to the + TRIG IN connector or push the MAN TRIG button. Maximum pulse repetition rate is 25 MHz. Input

trigger amplitude is 1 V to 3 V, with a maximum safe limit of 5 V (DC + peak AC). Input resistance of the connector is approximately 200 Ω .

2. Setting the Mode switch to the EXT GATED position and the PERIOD selector in any position except EXT TRIG, changes the period generator from a free running state to a triggered state.

a. Period generator is gated on, by applying an external positive-going gate pulse to the + GATE IN connector.

b. The output of the period generator is a burst of pulses within this gated interval. Pulse characteristics within the gated interval are set by the front panel MODE, DURATION, and DELAY controls. The period of these pulses is set by the PERIOD selectors. The period of the pulse burst is a function of the input gate frequency.

c. Input gate amplitude should be 1 V to 3 V. Maximum frequency is 25 MHz. Minimum off time is 20 ns.

The most desirable method of applying an external trigger or gate signal to the + EXT TRIG or + GATE IN connector is through a 50 Ω coaxial cable with BNC connectors and the necessary attenuators to bring the signal amplitude within the 1 V to 3 V range. If the input signal contains a DC component which prevents it from moving within the 1 to 3 volt range, it should be capacitively coupled. The time constant of the coupling network should be short for trigger signals, to obtain the full frequency capabilities of the instrument, and long for gate signals so the signal level remains above 1 volt for the duration of the gate. Input resistance at the connector is approximately 200 Ω .

OUTPUT PULSE CONNECTIONS

The output of the 2101 is designed as a current source to work into 50 Ω load. DC OFFSET and PULSE AMPLITUDE are calibrated for this 50 Ω load. An unloaded or improperly loaded output will produce overshoot, ringing and other distortion in the output pulse. Load impedances that are less than 50 Ω reduce the pulse amplitude and DC offset range but the pulse shape will not be distorted.

Basic Precautions

Output pulse characteristics can be preserved if the following precautions are followed and understood.

1. Use high quality 50 Ω coaxial cables and connectors for transporting pulses to and from the device under test.

2. Make all connections tight and insure that all connectors are tightly assembled.

3. Use high quality attenuators if needed, to reduce the pulse amplitude to sensitive circuits.

4. Use terminators or impedance matching devices to avoid reflections.

5. Insure attenuators, terminations, etc., have power handling capability for the combined output pulse amplitude and DC offset. Approximately 2.5 watts maximum. Power output is determined by offset current (40 mA maximum) and duty factor of output pulse current (200 mA \times d.f.).

Risetime and Falltime Considerations

If the output pulse from the 2101 is used for measuring the rise or falltime of a device, the risetime characteristics of associated equipment may have to be considered. If the risetime of the device under test is at least 10 times greater than the combined risetimes of the 2101 plus the monitoring oscilloscope and associated cables, the error introduced will not exceed 1% and generally can be ignored. If the rise or falltime of the test device, however, is less than 10 times as long the combined risetimes of the testing system, the actual risetime of the device will have to be determined from the risetime of each component making up the system. This equals the square root of the sum of the squares of the individual risetimes. Conversely the risetime of the device under test can be found from the same relationship if all the risetimes in the system are known except the device under test. Risetime and falltime of the 2101 output pulse is equal to or less than 5 ns.

The physical and electrical characteristics of the pulse transmitting cable determine the characteristic impedance, velocity of propagation, and amount of signal loss. Signal loss, due to energy dissipation in the cable dielectric, is proportional to the frequency; therefore, a few feet of cable can attenuate high frequency information in a fast-rise pulse. It is important, therefore, to keep these cables as short as possible.

When signal comparison measurements or time difference determinations are made, the two signals from the test device should travel through coaxial cables with identical loss and time delay characteristics.

If there is a DC voltage across the output load, the output pulse amplitude will be compressed, or in some cases; if the voltage exceeds ± 10 V, it may short the output. To prevent this from occurring, the output must be coupled through a DC blocking capacitor to the load. The time constant, of the coupling capacitor and load, must be long enough to maintain pulse flatness.

Impedance Matching

As a pulse travels down a transmission line, each time it encounters a mismatch, or different impedance than the transmission line, a reflection is generated and sent back along the line to the source. The amplitude and polarity of the reflections are determined by the amount of the encountered impedance in relation to the characteristic impedance of the cable. If the mismatch impedance is higher than the line, the reflection will be of the same polarity as the applied signal, if it is lower, the reflection will be of opposite polarity.

If the reflected signal returns before the pulse is ended it adds to or subtracts from the amplitude of the pulse. This distorts the pulse shape and amplitude. The following describes methods for matching impedance networks into relatively low impedances. If the 2101 is driving a high impedance, such as the 1 M Ω input impedance of the vertical input for an oscilloscope, the transmission line must be terminated into a 50 Ω attenuator and 50 Ω termination at the oscilloscope input. The attenuator isolates the input capacity of the device. Distortion can be caused by this input capacity.

A simple resistive impedance-matching network, that provides minimum attenuation, is illustrated in Fig. 2-7. To match

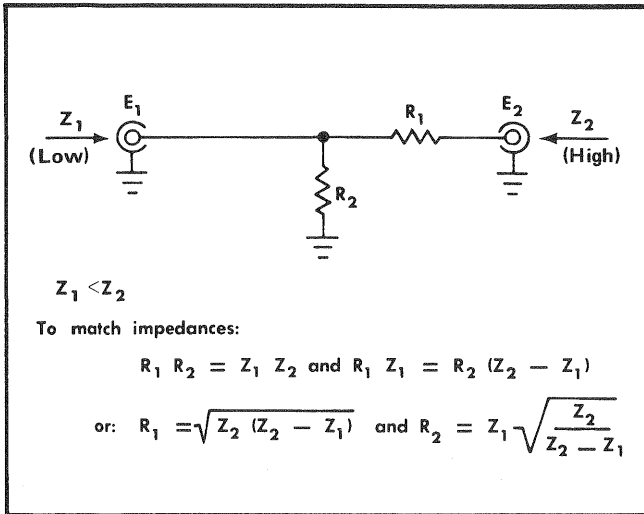

Fig. 2-7. Impedance matching network that provides minimum attenuation.

impedances with the illustrated network, the following conditions must exist:

$$\frac{(R_1 + Z_2)R_2}{R_1 + Z_2 + R_2} \text{ must equal } Z_1^*$$

and

$$R_1 + \frac{Z_1 R_2}{Z_1 + R_2} \text{ must equal } Z_2$$

Therefore:

$$R_1 R_2 = Z_1 Z_2; \text{ and } R_1 Z_1 = R_2 (Z_2 - Z_1)$$

$$\text{or } R_1 = \sqrt{Z_2 (Z_2 - Z_1)}$$

$$\text{and } R_2 = Z_1 \sqrt{\frac{Z_2}{Z_2 - Z_1}}$$

*The source impedance (Z_1) for the 2101 is 50 Ω when the 50 Ω INTERNAL TERMINATION is switched in and at least 1500 Ω when the back termination is switched out.

For example; to match a 50- Ω system to a 125- Ω system, Z_1 equals 50 Ω and Z_2 equals 125 Ω .

Therefore:

$$R_1 = \sqrt{125(125 - 50)} = 96.8 \text{ ohms}$$

$$\text{and } R_2 = 50 \sqrt{\frac{125}{125 - 50}} = 64.6 \text{ ohms}$$

When constructing such a device, the environment surrounding the components should also be designed to provide a transition between the impedances. Keep in mind that the characteristic impedance of a coaxial device is determined by the ratio between the outside diameter of the inner conductor to the inside diameter of the outer conductor ($Z_0 = 138 \log_{10} D/d$), where D is the inside diameter of the outer conductor and d is the diameter of the inner conductor).

Though the network in Fig. 2-7 provides minimum attenuation for a purely resistive impedance-matching device, the attenuation as seen from one end does not equal that seen from the other end. A signal (E_1) applied from the lower impedance source encounters a voltage attenuation (A_1) which is greater than 1 and less than 2, as follows:

$$A_1 = \frac{E_1}{E_2} = \frac{R_1}{Z_2} + 1$$

A signal (E_2) applied from the higher impedance source (Z_2) encounters a greater voltage attenuation (A_2) which is greater than 1 and less than 2 (Z_2/Z_1):

$$A_2 = \frac{E_2}{E_1} = \frac{R_2}{R_1} + \frac{R_1}{Z_1} + 1$$

In the example of matching 50 Ω to 125 Ω ,

$$A_1 = \frac{96.8}{125} + 1 = 1.77$$

and

$$A_2 = \frac{96.8}{64.6} + \frac{96.8}{50} + 1 = 4.44$$

The illustrated network can be modified to provide different attenuation ratios by adding another resistor (less than R_1) between Z_1 and the junction of R_1 and R_2 .

NOTES

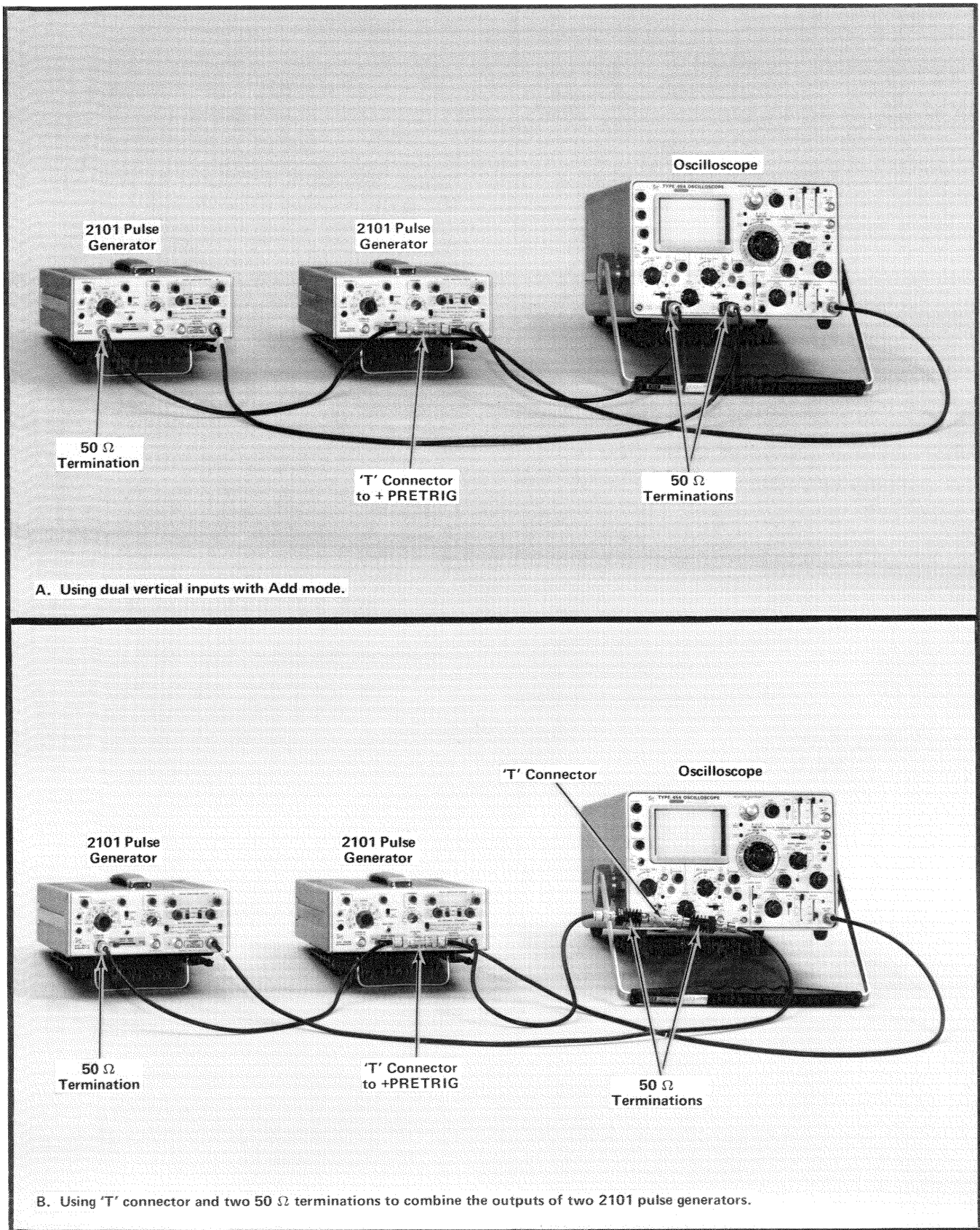

Fig. 2-8. Sample test equipment connection, using two 2101 Pulse Generators to obtain complex waveforms.

SECTION 3

CIRCUIT DESCRIPTION

Change information, if any, affecting this section will be found at the rear of the manual.

Introduction

This section describes the circuitry used in the 2101 Pulse Generator. A block diagram analysis is presented first, to provide the reader with an overall concept of the major circuit functions and their relationship with each other. Operational theory of each major circuit is then described in detail. The overall objective for this section is to provide sufficient understanding of the circuit theory so the reader can troubleshoot, calibrate and operate this instrument.

Functional block diagrams and simplified circuit schematics are included where they are applicable, to help illustrate circuit operation. Detailed diagrams are provided in the Diagrams section.

Block Diagram Description

A complete block diagram of the 2101 is illustrated in Figs. 3-1 and 3-2 and in the Diagrams section. The pulse-forming circuit diagrams are then redrawn to illustrate the basic modes of pulse operation. See Fig. 3-3.

The Undelayed Pulse Mode

The undelayed or delayed pulse is generated by either the internal period generator or by an external signal applied to the EXT TRIG connector.

In the NORM (normal) mode, the period generator free runs for all PERIOD selector positions except EXT TRIG. The period repetition rate of the generator is selected by the PERIOD controls.

Switching the PERIOD selector to the EXT TRIG position disables the PERIOD generator. A trigger pulse for the pulse-shaping circuits must come from the Trigger/Gate generator. Depressing the MAN TRIG button or applying a positive-going (1 V to 3 V) pulse to the + TRIG IN connector, will cause the monostable gate generator to toggle, sending a pulse to the pulse shaper circuits.

The period or external gate generator output pulse is shaped by a current mode switching circuit. This circuit switches very rapidly, which greatly enhances the rise and fall time of the pulse leading and trailing edges. The output signals from the current mode switch, are used for the + PRETRIG OUT signals and as trigger signals for the duration and delay generator circuits. The negative-going output pulse from the current mode switch is inverted through Q66 and applied through the MODE switch to either or both the delay and duration generator trigger circuits.

The UNDLY'D position of the MODE switch disables the delay generator and connects the output of the inverter

(Q66) to a second pulse shaper or Schmitt trigger circuit which triggers the duration generator. The duration generator is a monostable flip-flop whose output is a timed pulse duration that can be selected by the PULSE DURATION controls.

The output pulse (calibrated in duration) from the duration generator is then applied to a current mode switching circuit (Q194 and Q196) which further shapes the pulse and converts a single-ended input pulse to double-ended output pulses coincident in time. These two (positive and negative-going) pulses drive two separate (+ and -) pulse shaping and output amplifier circuits, so that simultaneous positive and negative-going pulses are provided at the OUTPUT connectors of the 2101.

Each output amplifier consists of a current mode switching circuit, to shape or speed up the rise and fall time of the pulse, and a current mode switching circuit with a controllable current source. This provides amplitude adjustment of the output pulse and a constant current source to drive the load connected to the OUTPUT connector. The current amplitude range of this circuit is 10 mA or less to 200 mA.

50 ohms of back termination can be switched in with the 50 Ω INTERNAL TERMINATION switches. With the back termination in, the OUTPUT appears as a 50 Ω voltage source. Voltage range is 1 volt or less to approximately 8 volts. This produces a pulse amplitude range across a 50 Ω load of 0.5 volt to 5 volts, or half the voltage across a 50 Ω load, that is available with the back termination switched out.

An offset generator, when switched in, provides a current to 40 mA maximum to offset the pulse baseline at the OUTPUT. This produces an output DC offset of + and -2 volts across a 50 Ω load. Current direction through the load establishes the offset polarity. The offset range, like the pulse amplitude range, is reduced by half when the back termination (50 Ω INTERNAL TERMINATION) is switched in.

Delayed Mode

When the MODE selector is switched to the DELAYED position, the delay generator is enabled and the pulse output from the inverter (Q66) is now applied to the delay generator circuit. The duration generator receives its trigger pulse from the delay generator so that, after some calibrated delay time, the duration generator is triggered and the output pulse delivered. The circuitry for the delay generator is the same as the circuit of the duration generator. The negative-going transition at the end of the pulse from the delay generator is used to trigger the duration generator circuit. Range of the two timing circuits is 20 ns to 4 s or more.

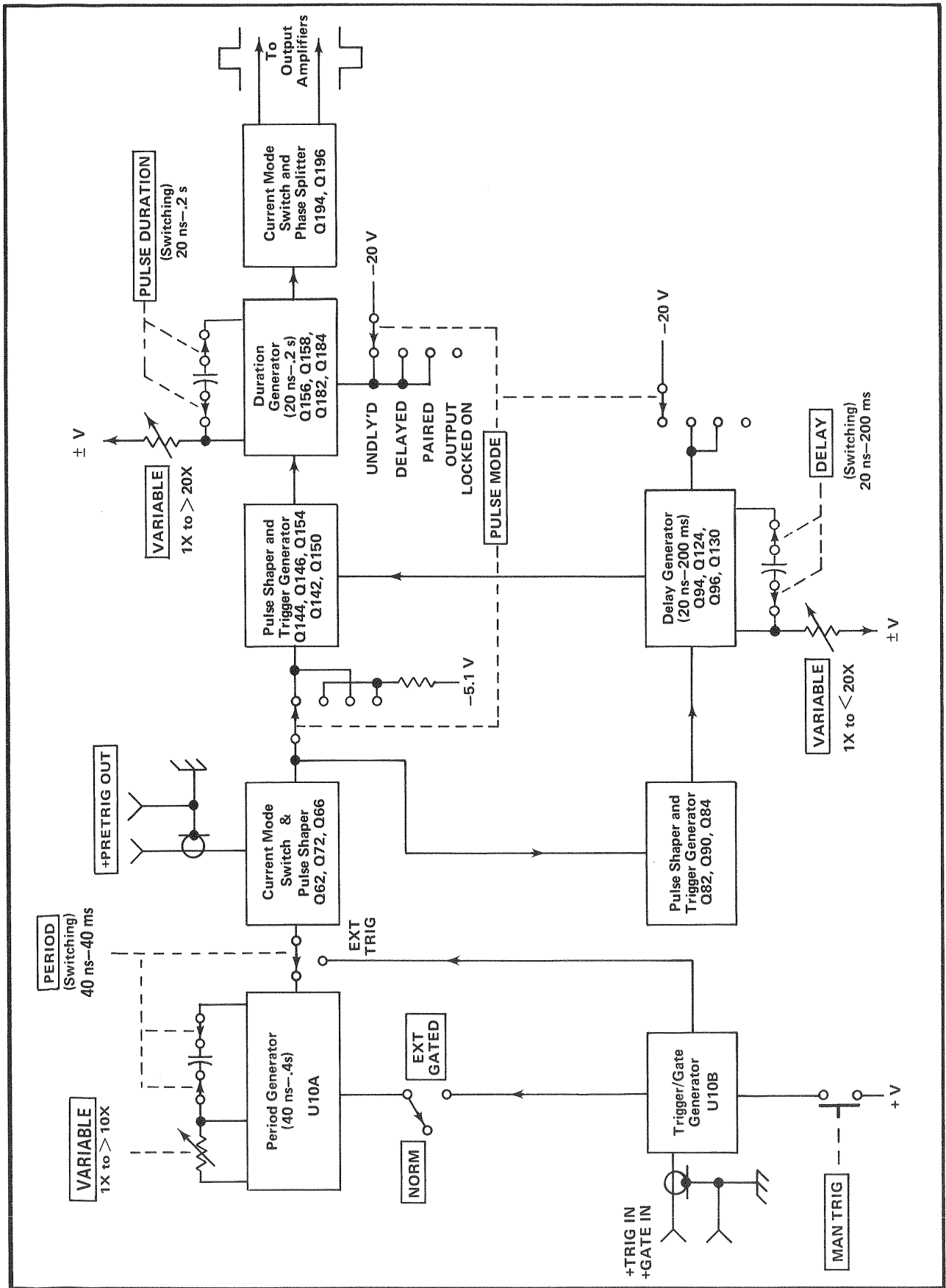

Fig. 3-1. Functional block diagram of the pulse forming circuits.

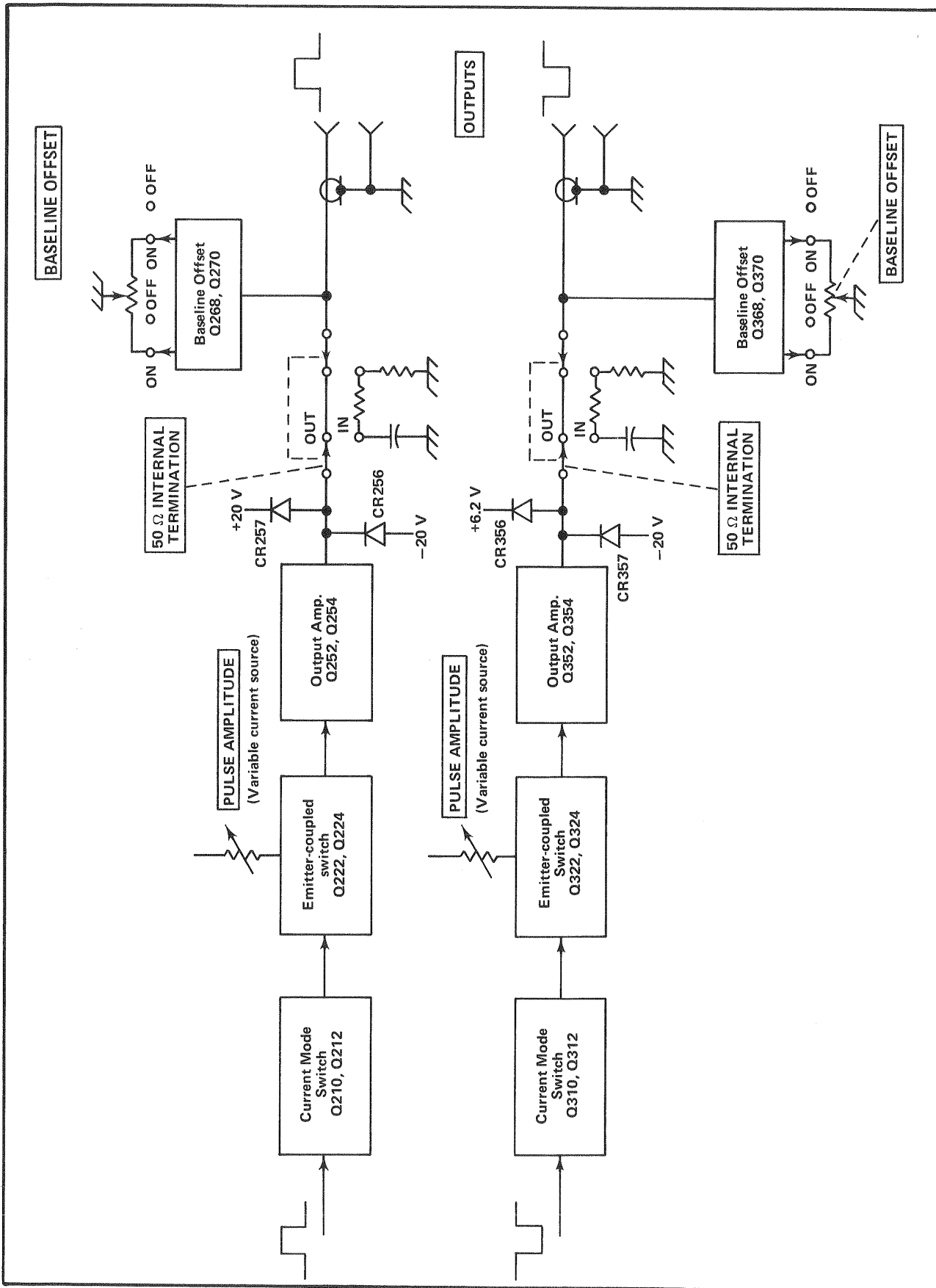

Fig. 3-2. Functional block diagram of pulse amplitude and output circuits.

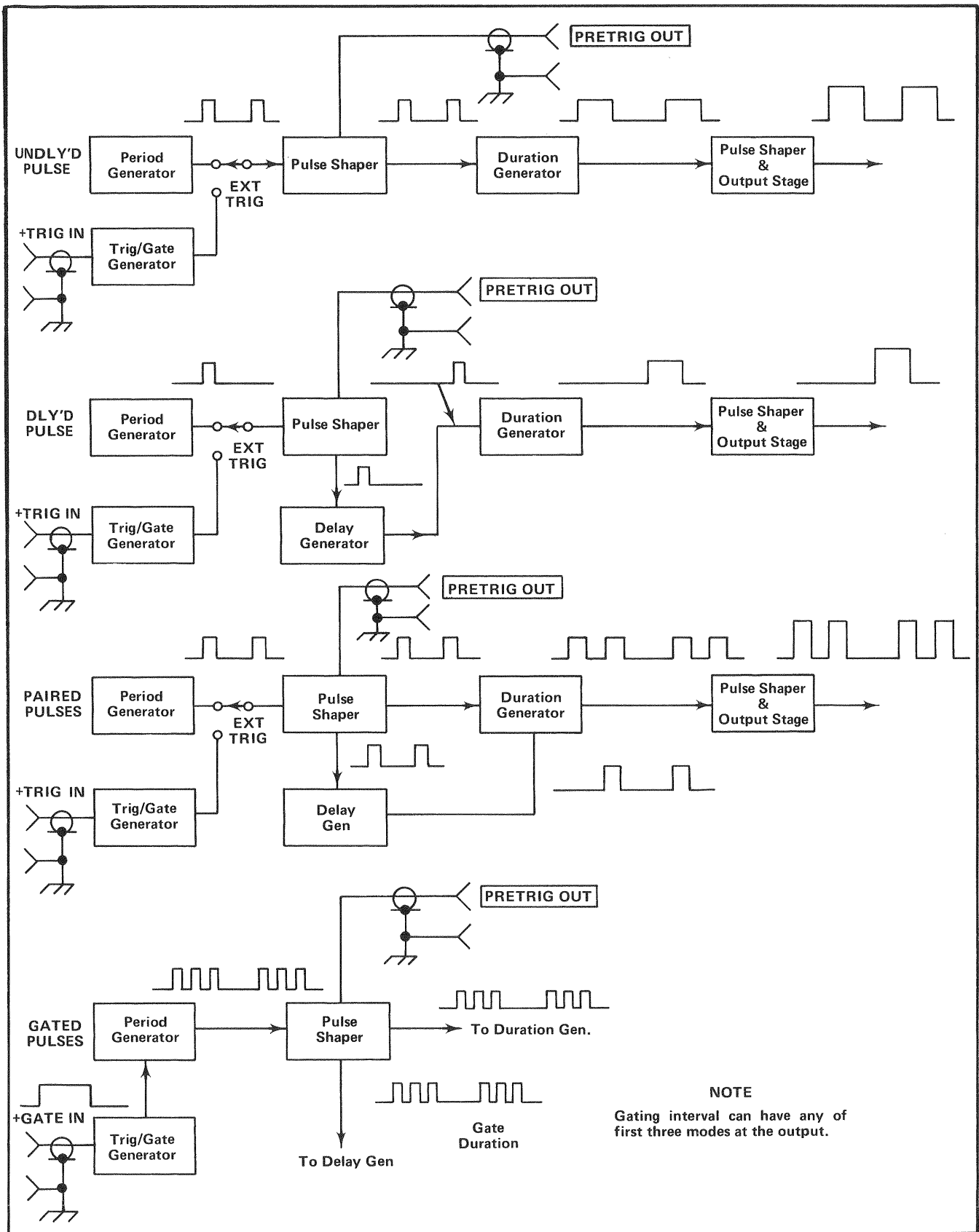

Fig. 3-3. Simplified block diagrams illustrating the four basic pulse outputs.

Paired Mode

With the MODE selector in the PAIRED position, the output pulse from the inverter (Q66) is applied to both the duration and delay generators. The output of the duration generator is now a pair of pulses within the pulse period. The duration generator is triggered twice within the pulse period by the undelayed pulse and the delayed pulse. Separation between the paired pulses (between the pulse leading edges) is determined by the settings of the DELAY selectors. Fig. 3-3 illustrates the pulse outputs for different modes. Minimum pulse separation between the paired pulses is 20 ns or 20% of the pulse duration, whichever is greater.

Output Latched On Mode

Both the delay and duration generators are disabled in the Latched On mode. The output is now a DC voltage equal to the pulse amplitude plus the baseline offset.

Gated Output

Switching the NORM—EXT GATED switch (S20) to the EXT GATED position, changes the state of the period generator from free running, to gated operation. The period generator can only toggle now during the positive portion of an externally applied gate pulse. The output of the period generator is a burst of pulses during the duration of the input gate pulse. The characteristics of these pulses within this gated interval are established by the MODE, DURATION, and DELAY controls. The period of these pulses within the burst is set by the PERIOD selection.

DETAILED CIRCUIT DESCRIPTION

This description assumes the reader has a knowledge of basic electronics; therefore, sections of the circuitry that can be considered basic are briefly described. Pull-out schematics (in the Diagrams section) at the rear of the manual as well as simplified illustrations within this section should be referred to as the description is read.

Pulse Period

The pulse period is determined by the internal period generator frequency, or the frequency of an externally applied trigger signal, when operated in the EXT TRIG mode. With the PERIOD selector in any position except EXT TRIG, U10A is connected through the cam timing switch as an astable multivibrator. Frequency of the multivibrator depends on the value of the feedback capacitors switched into the circuit between the OR output (pin 6) and the gate input (pin 4), plus the resistance between the NOR gate output (pin 5) and the input (pin 4). Simplified diagrams of the period generator are shown in Fig. 3-4 and Fig. 3-5.

Input pins 1, 2 and 3 of the OR/NOR gate are connected to the -5.1V supply and held low. When input pin 4 is low, all inputs to the gates are low. This sets the OR output (pin 6) low, and the NOR output (pin 5) high. The feedback capacitor (selected by the PERIOD cam switch) charges through the feedback resistance until pin 4 input level crosses from a low to a high state. The OR/NOR outputs then switch

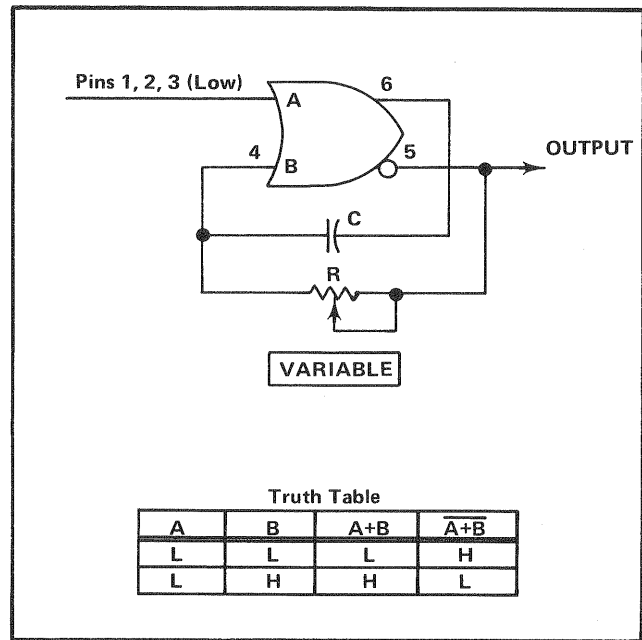

Fig. 3-4. Simplified illustration of period generator in the normal mode and logic truth table.

state and the capacitor discharges through the feedback resistor until the cross-over level is again reached, which again switches the multivibrator. Period of oscillation depends on the RC time constant of the feedback network.

In the GATED mode of operation, the NORM-EXT GATED switch S20, disconnects input pin 13 from its ground return through CR21. Pin 13 of the OR/NOR gate U10B is pulled low through R11. The NOR output (pin 9) connects to the input (pin 1) of the multivibrator U10A. With no external gate signal applied, all four inputs to U10B are held low, which sets the NOR gate output (pin 9) high. This high state, applied to input pin 1 of U10A, sets the state of the multivibrator so the NOR gate output (pin 5) switches low and holds.

Applying a + gate pulse (with an amplitude of 1 V minimum) to the input connector (J1), pulls the input at pin 10 of U10B high. This switches the NOR output of the gate (pin 9) low. All inputs of U10A except pin 4 are now low and the period generator will oscillate. Frequency or period of oscillation is set by the RC feedback combination selected by the PERIOD selector switch. The multivibrator continues oscillating for the duration of the input gate to J1. At the end of the pulse gate, it again assumes a stable state when the NOR gate output (pin 5) switches low and the OR gate output switches high.

Diode CR23, between the input pins 4 and 1 of the multivibrator, holds pin 4 near the switching state (0.9 V away from pin 1) so the incoming gate pulse will quickly switch the period generator to its free running state. Diode CR1 clamps the input (pin 10) of the OR/NOR gate U10B at approximately -0.6V and acts as a DC restorer so the input DC level at pin 10 remains fairly constant, with changes in input signal frequency. Diodes CR3 and CR2 limit the input trigger signal or gate amplitude to approximately 1.2 V.

External Trigger or Manual Trigger Operation

In this mode, the NORM-EXTGATED switch is in the NORM position and the PERIOD selector is in the EXT TRIG position. S1 (MAN TRIG) and cam No. 16 are open. Cam No. 15 is closed. With no input trigger signal applied, all inputs to the OR/NOR gate U10B, are held low. Applying a positive trigger pulse to the + TRIG IN connector, or closing the MAN TRIG switch S1, pulls the input at pin 10 up and switches the gate. The OR gate output (pin 8) switches high and is applied through cam No. 15 to the base of Q62. This positive gate to Q62 causes the current through R69 to switch from Q62 to Q72, which generates a fast-rise positive pulse output to + PRETRIG OUT connector J72, and causes a negative pulse at the base of Q66.

Current Mode Trigger Circuit and Pulse Shaper

Pulses from the period generator or external gated OR/NOR integrated circuit are applied through cam No. 15 contact to the base of Q62. Q62 and Q72 are the active components of a current mode switching circuit that will switch very rapidly when triggered. Current mode switching is used extensively in the 2101 to shape the pulse.

The common emitters of transistors Q62 and Q72 are returned, in a long tail configuration, through R69 to the +20 V supply. With no signal input, Q72 is off and Q62 conducts all the circuit current. R75 sets a reference voltage threshold on the base of Q72. When a positive input pulse to the base of Q62 crosses this reference voltage level, it switches Q62 off. The circuit current (through R69) is switched through Q72, generating a fast-rise positive step function at the + PRETRIG OUT connector and a negative pulse at the base of Q66. During the trailing edge of the input trigger pulse, when the input voltage crosses the threshold voltage level,

the circuit again switches, generating a fast fall-time for the output pulse trailing edge.

The negative-going pulse at the base of Q66 turns the transistor on hard, generating a positive-going output pulse at the collector. This is applied through PULSE MODE selector S120 to the pulse shaping and trigger circuits in the duration and delay generating circuits. L66 in the collector load of Q66 compensates for circuit lead capacitance and helps preserve the output pulse rise and fall time. The collector load impedance for Q66 is maintained at a constant value by the combination of R81 and either R66 or R144 for all positions of PULSE MODE switch S120.

Duration (Width) Generator

The duration generator consists of a Schmitt trigger shaping circuit driving a monostable multivibrator with a variable (RC) timing circuit to set the pulse duration. The RC timing switched into the multivibrator coupling network is selected by the DURATION selector. Pulse duration ranges from 20 ns to more than 4 s are available.

The Schmitt shaping circuit consists of transistors Q144, Q154 and Q150 or transistors Q142, Q154 and Q150. The selection of the input pulse (to Q144 or Q142) depends on the mode of pulse operation. When the PULSE MODE selector is at the UNDLY'D position, the delay circuit is disabled by interrupting the return for Q94 and Q124 emitters to the -20 V supply. Q124 is turned off, which back-biases Q124 and Q146. Q144 and Q154 are therefore the active components in a Schmitt multivibrator configuration, with Q150 between the two collector loads. With no input signal to Q144, Q154 is conducting and both Q150 and Q144 are off. R155 sets the bias level and hysteresis width for the Schmitt multivibrator circuit.

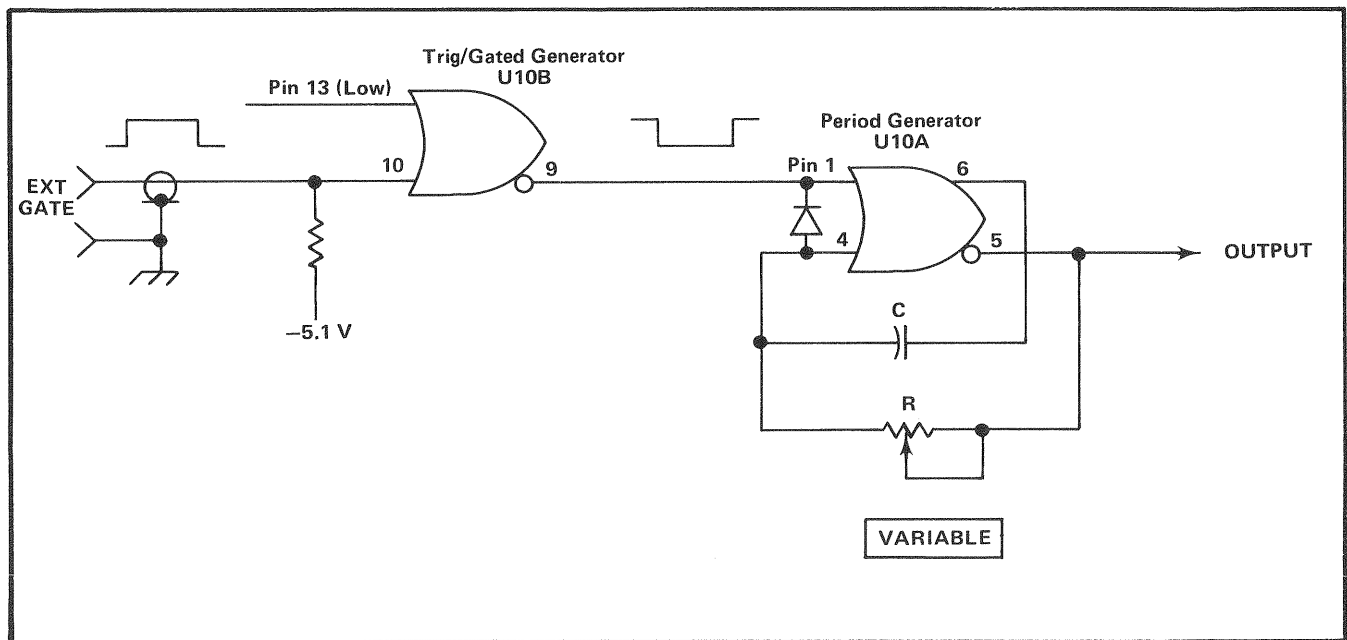

Fig. 3-5. Simplified diagram of pulse (period) generator during gated input operation.

A positive-going input pulse to the base of Q144 turns this transistor on and switches the Schmitt multivibrator so Q154 is turned off. This produces a positive pulse on the emitter of Q150 and a negative pulse, from Q144, on the base of Q150. This pulse combination switches Q150 on hard. The base-emitter junction of Q150 is across the collectors of Q144 and Q154. Since it requires only 0.6 V difference between the collectors of Q144 and Q154 to drive Q150 into conduction, the positive output pulse at the collector of Q150 is free of any baseline irregularities that may be present in the pulse output of Q154.

Switching the PULSE MODE selector to the DELAYED position interrupts the signal path to the base of Q144 and connects the emitter of Q94 and Q124 to -20 V, enabling the delay generator. Q146 now becomes part of the duration generator Schmitt trigger circuit. The Schmitt circuit now receives its trigger pulse from the delay generator.

When the PULSE MODE selector is switched to the PAIRED position, both the duration and delay generators are enabled. The output pulse from Q66 triggers the Schmitt circuit (Q144, Q154) for the duration generator and the Schmitt trigger circuit (Q82, Q90) for the delay generator. Therefore, some calibrated delay time after the initial gated pulse output from the duration generator, a second trigger pulse from the delay generator switches the duration generator Schmitt trigger circuit and a second pulse is generated. These pulse pairs provide the paired output for the 2101 Pulse Generator.

In the LATCHED ON mode, both pulse delay and pulse duration circuits are disabled. Since there is no input pulse to Q196 from the duration generator, the outputs of Q194 and Q196 are locked in a stable state with Q194 off and Q196 on.

The pulse duration generator is a monostable multivibrator with a timing circuit that provides a greater timing range than is feasible with a basic monostable multivibrator. The period of the basic monostable multivibrator is limited because a part of the total timing current is required to keep the circuit stable. In this circuit, when the multivibrator is in its stable state waiting for a trigger pulse, holding current for the on transistor is supplied by transistor Q184. When the trigger pulse arrives, Q182 and Q184 are turned off. Timing current therefore starts from zero when it charges the timing capacitor. This provides approximately twenty times more timing range run-up than the basic monostable multivibrator circuit.

Prior to the arrival of a trigger pulse from the Schmitt multivibrator, Q156 is off, Q182 and CR182 are on. Emitter follower Q158 conducts all the time and provides current to help decrease the recovery time of the timing capacitor. When a positive trigger pulse is applied to the base of Q156, it turns this transistor on, pulling the base and emitter of Q158 negative. This negative pulse, coupled through the timing capacitor to the base of Q182 and the anode of CR182, turns both Q182 and CR182 off. The resultant positive step of voltage, on the collector of Q182 is the start of the output gate pulse. The multivibrator will remain in this state until the voltage at the base of Q182 can charge the timing capacitor above the voltage level present at the base of Q156.

Current, to charge the timing capacitor positive, flows through the timing resistors in the duration timing circuit. This timing current sets the time period (duration) for the capacitor

to charge to the same voltage level as that on the base of Q156. When the voltages are equal, Q182 and Q184 switch on and Q156 switches off. Diode CR182 turns on, clamps the voltage at the base of Q182, and completes the recharge path for the timing capacitor. The circuit is now ready for another trigger pulse.

Minimum current requirement for the circuit is the current required to keep Q182 on. Maximum current is limited by the power limits of CR182. When Q182 is on, Q184 is also switched on, and supplies the current to hold Q182 on. When Q182 switches off, Q184 is turned off. Current for Q182 therefore, has no effect on the timing circuit since Q184 supplies the holding current for Q182 during its on time. Timing current is now independent of holding current and can be set at a much lower value.

The output stage for the pulse generating circuits converts the single ended pulse from the duration generator to a double ended pulse. These positive- and negative-going pulses, coincident in time, drive two identical amplifying channels in the output amplifier. Q194 and Q196 are part of a current mode switching circuit. Reference voltage for the circuit is set, by the combination of Zener diode VR187 and CR187, to 5.1 V. With no input signal, Q194 conducts all the common emitter current. The collector of Q194 is therefore down to approximately 1.4 volts and the collector of Q196 is at ground potential. When the input positive-going pulse to the base of Q196 crosses the 5.1 V threshold potential, the current switches from Q194 to Q196. This generates a fast-rise negative pulse at the collector of Q196 and a positive-going pulse at the collector of Q194. These coincident pulses are directly coupled to both channels of the output amplifier circuit.

Delay Generator

The delay generator circuit is similar in operation to the duration generator. It, like the duration generator, consists of a Schmitt multivibrator driving a monostable multivibrator with a variable timing circuit. The output pulse from the monostable multivibrator is developed across R135 plus an inductive load (L136). At the end of the pulse duration, a negative pulse is developed across L136. This negative pulse is inverted by Q142 and triggers the Schmitt trigger circuit for the pulse duration circuit. The delay generator therefore provides a delayed trigger pulse to the duration generator trigger circuit some delay time after the pulse output from Q66.

The positive-going output pulse (at the collector of Q84) from the Schmitt multivibrator switches Q94 on and Q124-Q130 off. Transistors Q94, Q96, Q124 and Q130 are the active components in the monostable multivibrator circuit. The operation of the multivibrator is the same as that of the duration generator multivibrator. The positive-going output pulse at the collector of Q124 are developed across R135 and L136 and clamped at approximately 0.9 V by diodes CR135 and CR136 (CR136 is germanium and CR135 is silicon). At the end of the positive gate, when Q124 is switched on, a negative pulse is generated across L136 and applied to the base of Q142. Q142 inverts this negative-going trigger pulse and isolates the trigger generating circuit from the Schmitt duration generator trigger circuit. The output of Q142, applied to the base of Q146, triggers the Schmitt multivibrator and produces the delayed pulse out of the duration generator.

Pulse Mode Switching

The emitters of Q94 and Q124, in the delay generator, and Q156 and Q182, in the duration generator, are connected through the PULSE MODE switch to the -20 V supply when the circuits are enabled. This connection is interrupted and the circuits disabled when their operation is no longer required. Diodes CR121 and CR181 clamp the emitters at approximately -10 V to prevent voltage surges which may exist when the PULSE MODE selector is switched, from appearing across the base-emitter junctions of Q156, Q182, Q94 and Q124.

Output Amplifiers

The output amplifiers consist of two (+ and $-$) pulse shaping and amplifying circuits. The OUTPUT connectors provide coincident + (plus) and $-$ (minus) pulses from a current source of 200 mA with up to 40 mA baseline offset. Independent control over the pulse amplitude and baseline offset is provided by separate controls for each OUTPUT. A $50\ \Omega$ INTERNAL TERMINATION can be switched in as back termination for the output connectors.

The push-pull pulse signals, from Q194 and Q196, are directly coupled to two current mode switching circuits; Q210-Q212 and Q310-Q312. The input to Q210 is in parallel with the input to Q310 and the input to Q212 is in parallel with Q312. With no signal input, Q210 and Q310 are off and Q212-Q312 conduct the common emitter current. Input pulses to the current mode switching circuits produce positive step function at the collectors of Q212 and Q312 and negative gates at the collectors of Q210 and Q310 for the duration of the input pulses.

Q222 and Q224 are also connected as an emitter coupled switch with a variable gain control in the emitter circuit. The + PULSE AMPLITUDE control adjust the output pulse amplitude by setting the current level through the current mode switching transistors. Increasing the current level through the circuit increases the voltage swing at the collectors when the transistors are switched on or off. LR229 in the emitters of Q222 and Q224 compensate for circuit capacitance in the emitter leads, improving the circuit switching time. CR235 provides temperature compensation for the output transistors (Q252, Q254).

Q254 and Q252 (for the + pulse channel) are connected in parallel between the collectors of Q222 and Q224. Their emitters are DC coupled to the collector of Q222 and their bases are DC coupled to the collector of Q224. When the current mode switching circuit Q222 and Q224 is triggered by an incoming pulse, the output pulses at their collectors are applied across the base-emitter junctions of Q252 and Q254. This drive decreases the turn on or turn off time of these output transistors. Pulse risetime and falltime are therefore preserved.

C242 in parallel with C241-R241, between the collector of Q222 and the emitters of Q252 and Q254, provides series RC peaking adjustment of the pulse shape. C243 provides compensation adjustment for the shunt RC peaking circuit (C245-R245) in the emitter circuit of Q252 and Q254. R252 and R254, in the emitters of Q252 and Q254, provide temperature compensation and stability for the output transistors.

The amplitude of the pulse out depends on the current drive from Q222-Q224 and the gain through Q252-Q254. Gain of the output amplifier Q252-Q254 depends on the load for the collectors. The source impedance for the OUTPUT connector (collector to emitter impedance of Q252-Q254) is approximately $2\text{ k}\Omega$. The amplifier will supply at least 200 mA to the output load. (Range of the AMPLITUDE control is from 4 mA or less to 200 mA.) With the $50\ \Omega$ INTERNAL TERMINATION switch OUT, 200 mA will produce a pulse amplitude of 10 V across a $50\ \Omega$ external load. Switching S280 to the IN position connects a back termination of $50\ \Omega$ to the OUTPUT connector. This back termination can be used when the pulse generator is driving a high impedance load. For most applications the generator should be terminated in $50\ \Omega$. If the $50\ \Omega$ INTERNAL TERMINATION is switched in and the OUTPUT is terminated into $50\ \Omega$, the collector load for the output amplifier decreases to $25\ \Omega$ and the pulse amplitude to a range of 100 mV drops to 5 V.

Baseline Offset

A baseline offset of + or $-$ 2 volts, into a $50\ \Omega$ external load is provided by complementary transistors (Q268-Q270 and Q368-Q370). The transistors are connected in a differential amplifier configuration with the output connected across the OUTPUT load. A common heat sink for the transistors provides the thermal balance for the differential amplifier.

With the BASELINE OFFSET switched IN, the control sets the differential current through the two halves of the amplifier. At electrical center, current through the two sections is equal, which provides zero voltage or ground potential at the common collectors. As the BASELINE OFFSET control is rotated away from electrical center, a differential bias is supplied to the two emitter-base junctions of the transistors, producing a current differential through the two sections of the amplifier. Since the current through one section exceeds the current through the other, the differential current must flow into or out of the external load. This differential current produces a positive or negative voltage across the OUTPUT load. Rotating the BASELINE OFFSET control towards the positive end pulls the DC output level more positive.

R273 and R275, in parallel with L273 and L275 plus L274, isolate the capacitive loading of the differential amplifier circuit from the OUTPUT connector to preserve the pulse rise and fall time. With the BASELINE OFFSET switch (S255-S355) in the OFF position, the bases of the two transistors are referenced back to their emitter supply through R265-R267 and R365-R367, cutting the transistors off. The two transistors supply at least 40 mA to the output load. Diodes CR256 and CR257, in the positive channel, limit the output (pulse amplitude plus the baseline offset) to about + or $-$ 20.6 volts. Disconnecting the output load will generate excessive voltage peaks due to inductive kickback. These voltage surges are limited in positive direction by CR256 and in the negative direction by CR257. In the negative output circuit, CR357 is connected between the output and -20 V supply to limit the OUTPUT at approximately -20.6 V and CR356 is connected to the $+6.2\text{ V}$ supply to limit the positive swing to about $+7\text{ V}$.

Timing Circuits

The period, duration, and delay time of the output pulse or pulses are selected by switching different RC timing combinations into the period, duration, and delay generator feedback circuits. Three multicam switches (PERIOD, DURATION and DELAY) select these timing combinations (see Timing Circuit diagram).

Period: The timing switches schematic in the Diagrams section show the switches in the CCW position. This sets the PERIOD selector in the 40 ns position. Cams 1, 4 and 16 close their respective contacts. All the other contacts are open. The contact on cam No. 1 grounds the anode of CR21, which pulls one input (pin 13) on U10B high. This sets the OR output (pin 8) high and the NOR output (pin 9) low. Both the manual and external trigger, are now locked out. The RC timing circuit, in the period multivibrator feedback loop is changed as follows: Cam No. 4 closes and cam No. 3 opens to select a lower resistance value (R55, R56 in place of R58, R59). Cam No. 20 now opens and, all timing capacitors except C40 and C41 are switched out.

As the PERIOD selector is rotated clockwise, switch closures are indicated by the dots in the position indicating window for each cam.

Adjusting C40 calibrates the PERIOD VARIABLE control range with the PERIOD selector in the 40 ns position. R55 calibrates the minimum period (40 ns) position. C50 calibrates the VARIABLE control range at the 0.4 μ s position and R58 calibrates the 0.4 μ s period.

Pulse Duration: With this selector in the 20 ns position, cam numbers 18 and 16 close their contacts and cam number 15 opens its contact. The timing capacitors for this position are C165 in parallel with C166. The timing resistance is the combination of resistors R161, R167 in parallel with R163 and R165, plus the VARIABLE control R175A. Cam No. 16 connects the timing resistors to +5.1 volts to increase the timing current for the 20 ns position.

C165 calibrates the VARIABLE PULSE DURATION range at the 20 ns position. R165 calibrates the minimum pulse duration (20 ns). R179 calibrates the 0.2 μ s pulse duration. C161 calibrates the VARIABLE range and R161 calibrates the duration for the 2 μ s position.

Delay (S100): The fully counterclockwise position of this selector is the 20 ns position which closes cams number 8 and 6. This selects capacitors C102 in parallel with C101 as the timing capacitance and R101, R107 in parallel with R105 and R103, plus the VARIABLE control R115A, as the timing resistance. R105 calibrates the delay for the 20 ns position and C102 calibrates the VARIABLE control range. R118 calibrates the delay for the 200 ns position and R101 calibrates the delay for the 2 μ s position.

Power Supplies

The 2101 will operate from either a 115-volt or 230-volt, 48 Hz to 440 Hz line voltage source. The power supply (see Power Supply diagram in section 8) consists of transformer

T401, with two primary and two secondary windings, and two bridge rectifiers supplying the voltage source for two main voltage regulator circuits. The power supply furnishes regulated DC voltages for the 2101 circuits.

The input circuit consists of two multi-tap primary windings that can be connected (by means of a 115-V or 230-V selector switch S403) in parallel for 115-V operation or in series for 230-V AC operation. Each primary winding has three taps which increase or decrease the transformer turns ratio. Switching Line Range selector S404 between the LO, MED and HI positions provides an input AC voltage range from 90 V AC to 135 V AC or 180 V to 272 V AC. (See Power Requirements, Characteristic section.)

Temperature protection is provided by thermal cutout S402. Overload protection is provided by fuses F401 for 115 V operation and F403 for 230 V operation.

+20-VOLT SUPPLY: The +20-volt supply consists of a bridge rectifier CR410 (connected across secondary terminals 10 and 11 of T401), filter capacitor C410 and a voltage regulator circuit containing U410, Q412 and Q420.

The rectified DC output voltage from the rectifier and filter is applied across a series regulating transistor Q420 and the +20 volt regulated bus terminal. The current demanded by the load is regulated, through pass transistor Q420, by an integrated voltage regulator circuit U410. Q412 clamps the voltage level across U410 at approximately 36 volts to protect the IC voltage regulator in case the 2101 is connected to a power source that exceeds the selections of input voltage selectors S403 and S404.

A functional block diagram, showing the equivalent circuit, of IC regulator U410 is shown in Fig. 3-6. The output (terminal 6) supplies the regulator voltage to the base of series pass transistor Q420. Input terminal 10, samples the load current through the pass transistor. If this current exceeds the power supply capabilities (i.e. short circuit), it limits the base current of the IC series pass transistor which then limits base current for Q420. Input terminal 3 is the non-inverting input, and terminal 2 is the inverting input to a comparator amplifier. Frequency compensation, in the form of C415, for high frequency noise is connected between pin 9 and the non-inverting input terminal.

Operation of integrated circuit U410 (see Fig. 3-6) is as follows: A sample of the output voltage is applied to the inverting input (pin 2) from Voltage Adjust potentiometer R415. This sample of the output voltage is compared with the reference voltage (from the reference voltage amplifier applied to the non-inverting input pin 3). The differential voltage output then controls the bias of the series pass transistor, which supplies the base current for the external series regulator transistor, Q420. Any voltage change in the output will be amplified by the error amplifier in the IC U410 and applied as a corrective signal to the IC series transistor. The pass transistor output then drives the external series regulator Q420 to compensate for load change.

-20-VOLT SUPPLY: This supply consists of the bridge rectifier, CR430, connected across secondary terminals 12 and 13 of T401, the filter capacitor, C430, and the voltage regulator circuit containing U430 and Q440.

The rectified DC output voltage from the bridge rectifier is applied across series regulator transistor Q440 and ground,

Circuit Description—2101

then through the -20 V load resistance to the -20 V buss terminal. Current for the load is supplied by the series regulating transistor. Regulation of the transistor forward bias is controlled by integrated circuit voltage regulator U430. Q432 insures that the voltage level across IC U430 does not exceed approximately 36 V .

Operation of IC voltage regulator U430 is the same as that of U410 in the $+20\text{ V}$ supply description.

-10.5-VOLT SUPPLY : This supply (see Power Supply Diagram) consists of pass transistor Q444 and associated circuitry. Current through transistor Q444 is regulated by its base voltage which is set by the voltage divider network VR444 in series with CR444, CR443, and R443. This voltage

divider sets the base voltage of Q444 at about 10.8 volts and the output at approximately 10.1 volts .

$-5.1\text{-VOLT SUPPLIES}$: These two supplies contain a 5.1 V Zener in series with a dropping resistor connected between the -20 V supply and ground. Two supplies are used to provide circuit isolation between the period generator and the pulse forming circuits. The -5.1 V (A) supply furnishes the voltage for the period generator and the -5.1 V (B) supply furnishes voltage for the pulse forming circuits.

$+5.1\text{-V AND } 6.2\text{-V SUPPLIES}$: These supplies, like the -5.1 volt supplies, use a Zener diode and dropping resistor between the $+20\text{ volt}$ supply and ground to obtain an isolated and regulated supply. The $+5.1\text{ V}$ supplies the timing circuit voltage for the duration generator in the 20 ns position. The $+6.2\text{-volt}$ supply provides voltage for the positive limiting diode (CR356) in the $-$ output.

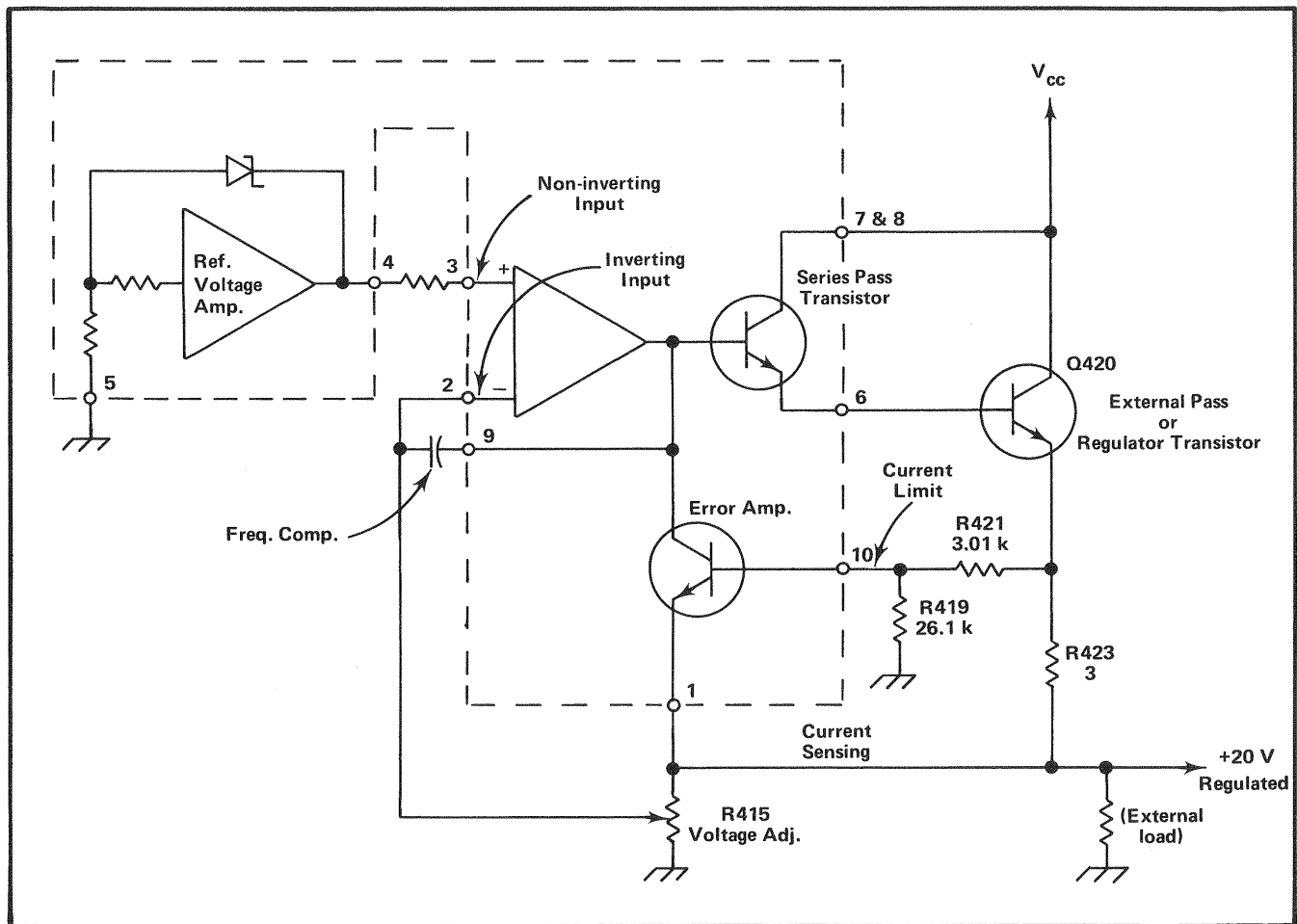

Fig. 3-6. Equivalent circuit of $+20\text{-volt}$ regulator.

SECTION 4

MAINTENANCE

Change information, if any, affecting this section will be found at the rear of the manual.

Introduction

This section describes recommended procedure for reducing or preventing instrument malfunction, troubleshooting, and corrective maintenance to repair the instrument. Preventive maintenance improves instrument reliability. If the instrument should fail to function properly, corrective measures should be taken immediately, otherwise additional problems may develop within the instrument.

Access to the Interior

Disconnect the power cord from the power source before removing the instrument covers. The top and bottom covers of the 2101 are removed by turning the four latching screws a quarter turn counter-clockwise to their stop, then lift the cover off the instrument.

After the covers have been removed, the power cord may be reconnected to a power source and the power switched ON.

Custom Capacitor Installation in the Timing Circuits

A special position is provided on the pulse characteristic selectors (PERIOD, PULSE DURATION, and DELAY) which provides a unique (custom selected) timing characteristic. The location of the pin connectors for these capacitors is shown in Fig. 4-1. Install the capacitors as follows:

1. Pull the respective (period, duration, or delay) connector from the board pins.
2. Solder the capacitor across the terminals of the plug connector as shown in Fig. 4-1. The pin connector can be removed from its holder by prying the top of the connector out of its locked position in the holder with a small bladed screwdriver.
3. Plug the connector, with the mounted capacitor, back on the board pin connectors (see Fig. 4-1). Insure that the capacitor leads are clear of other terminals to prevent electrical shorts.

PREVENTIVE MAINTENANCE

Preventive maintenance consists of cleaning, visual inspection, performance check, and if needed, a recalibration. The preventive maintenance schedule that is established for the instrument should be based on the environment the instrument is operated in and the amount of use. Under average conditions (laboratory situation) a preventive maintenance check should be performed every 1000 hours of instrument operation.

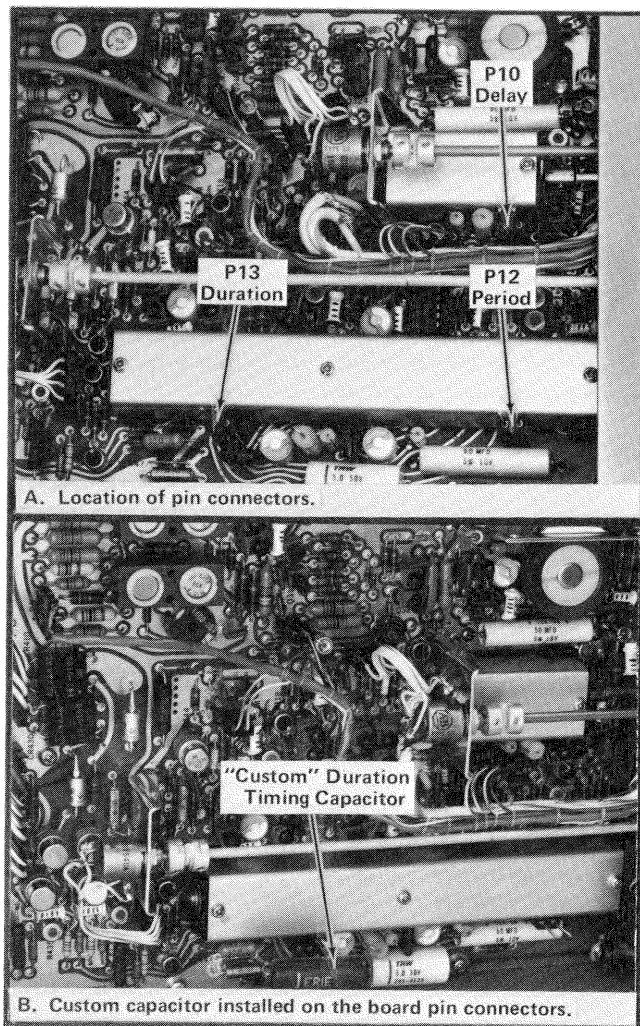

Fig. 4-1. Installing custom timing capacitors.

Cleaning

Clean the instrument often enough to prevent dust or dirt from accumulating in or on the instrument. Dirt acts as a thermal insulating blanket and prevents efficient heat dissipation and if it becomes damp it may provide electrical high resistance leakage paths between conductors and/or components.

Exterior—Clean the dust from the outside of the instrument by wiping or brushing the surface with a soft cloth or small brush. The brush will remove dust from around the front panel selector buttons. Hardened dirt may be removed with

a cloth dampened in water that contains a mild detergent. Abrasive cleaners should not be used.

Interior—Normally the interior of the instrument will not require cleaning unless the cover has been left off the instrument for an extended period of time. Clean the interior by loosening accumulated dust with a dry soft brush, then remove the loosened dirt with low pressure air to blow the dust clear. High velocity air should not be used because it may damage some components. Hardened dirt or grease may be removed with a cotton tipped applicator dampened with a solution of mild detergent in water. Abrasive cleaners should not be used. After cleaning the interior, allow it to dry thoroughly before applying power to the instrument.

CAUTION

Do not permit water to get inside the cam switches, variable potentiometers, or capacitors. Instructions for disassembling the cam switches and repairing are provided in Corrective Maintenance section. Do not clean any plastic materials with organic cleaning solvents such as benzene, toluene, zylene, acetone or similar compounds. These compounds may damage the plastic.

Lubrication

No components in this instrument require lubrication. The cam switches are self-lubricating.

Visual Inspection

After cleaning, the instrument should be carefully checked for such defects as poor connections, damage parts, and improperly seated transistors and integrated circuits. The remedy for most visible defects is obvious; however, if heat-damage parts are discovered, determine the cause of overheating before the damage parts are replaced. Otherwise the damage may be repeated.

Transistor and Integrated Circuit Checks

Periodic checks of the transistors and integrated circuits are not recommended. The best measure of performance is the actual operation of the component in the circuit. Performance of these components is thoroughly checked during the performance check or recalibration and any substandard transistors or integrated circuits will usually be detected at that time.

Performance Checks and Recalibration

To ensure accuracy, the instrument performance should be checked after each 1000 hours of operation or every six months if the instrument is used intermittently. The Performance Check and Calibration Procedure may assist in locating troubles that may not be apparent during regular operation. Instruction for conducting a performance check or calibration are provided in Section 5.

TROUBLESHOOTING

The ability to recognize and locate trouble is acquired through experience and familiarity of the instrument. The following test describes a few aids that may assist in locating a trouble. After the defective component has been located, refer to Corrective Maintenance procedures for removal and replacement instructions.

Troubleshooting Aids

Diagrams: Complete circuit diagrams are provided on foldout pages in the Diagrams section. The component numbers and electrical values are shown on the diagrams along with significant voltages and waveforms. Each major circuit is assigned a series of numbers for the electrical components. Table 4-1 lists these circuits and the number series assigned. Circuits mounted on circuit boards are outlined with a dashed blue line.

NOTE

Corrections and modifications to the circuits are described on inserts bound into the rear of the manual. Check for changes to the manual or the instrument.

**TABLE 4-1
COMPONENT NUMBERS**

Component Numbers on Diagrams	Diagram Numbers	Circuit
1-199	1 & 3	Timing Circuits and Timing Switches
200-399	2	Output Amplifiers and Offset Generator
400-499	4	Power Supplies

Circuit Board Illustration: Each electrical component and test point is identified on pictorial circuit board illustrations at the end of this section. These illustration together with circuit diagrams allow the troubleshooter to methodically trace the operation of each circuit.

Wiring Color Code. Color coded wire is used to aid circuit tracing. Power supply, DC voltage leads have either a white background for positive voltage or a violet background for negative voltage. The EIA standard color code is used to signify the approximate voltage value on the wire. The widest strip denotes the first significant figure.

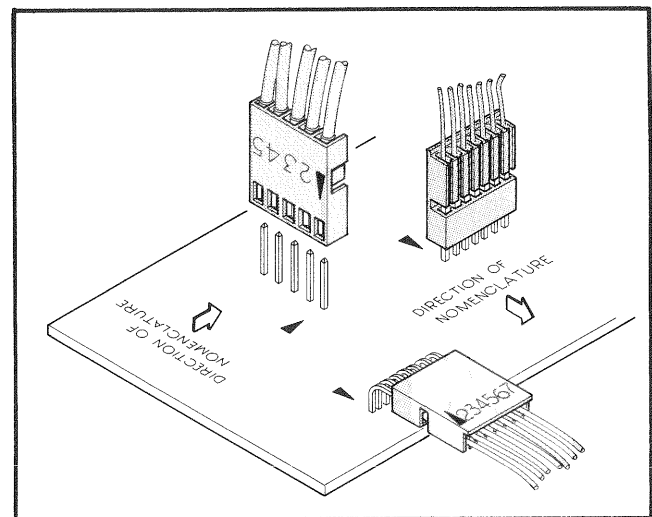

Fig. 4-2. Multipin circuit board connectors.

Signal wires and cable use an identifying one band or two band color code.

Multiple Terminal Connector Holders. Most inter-circuit connections, between the circuit boards or between the boards and chassis mounted components, are made through pin connectors. The terminals in the connector holder are identified with numbers. Connector orientation to the circuit board is keyed with triangles, one on the holder and one on the circuit board. See Fig. 4-2.

Resistor Color Code. In addition to the brown composition resistors, some metal-film resistors (identifiable by their gray body color) and some wire-wound resistors (usually light blue or gray-green) are used in the 2101. The resistance value of a wire-wound resistor is printed on the body of the component. The resistance value of a composition resistor or metal-film resistor is color-coded on the component with EIA color-code (some metal-film resistors may have the value printed on the body). The color-code is read starting with the strip nearest the end of the resistor. Composition resistors have four stripes which consist of two significant figures, a multiplier and a tolerance value (see Fig. 4-3). Metal-film resistors have five stripes consisting of three significant figures, a multiplier and a tolerance value.

Capacitor Marking. The capacitance value of a common disc capacitor or small electrolytic is marked in microfarads on the side of the component body. The white ceramic capacitors used in the 2101 are color coded in picofarads using modified EIA code (see Fig. 4-3).

Diode Color Code. The cathode of each glass encased diode is indicated by a stripe, a series of stripes or dot. Fig. 4-4 illustrates types of diodes used in this instrument.

Transistor and Integrated Circuit Electrode Configuration. Lead identification for the transistors and IC's are shown in Fig. 4-5 and Fig. 4-6.

General

If trouble occurs in the 2101, the following procedure should facilitate locating the problem and expedite repairs.

1. Insure that the malfunction exists in the instrument. Check operation of the associated equipment and the operating procedure of the 2101 (see Operating Instructions).
2. Determine and evaluate all trouble symptoms. Try to isolate the problem to a circuit or assembly. For example:

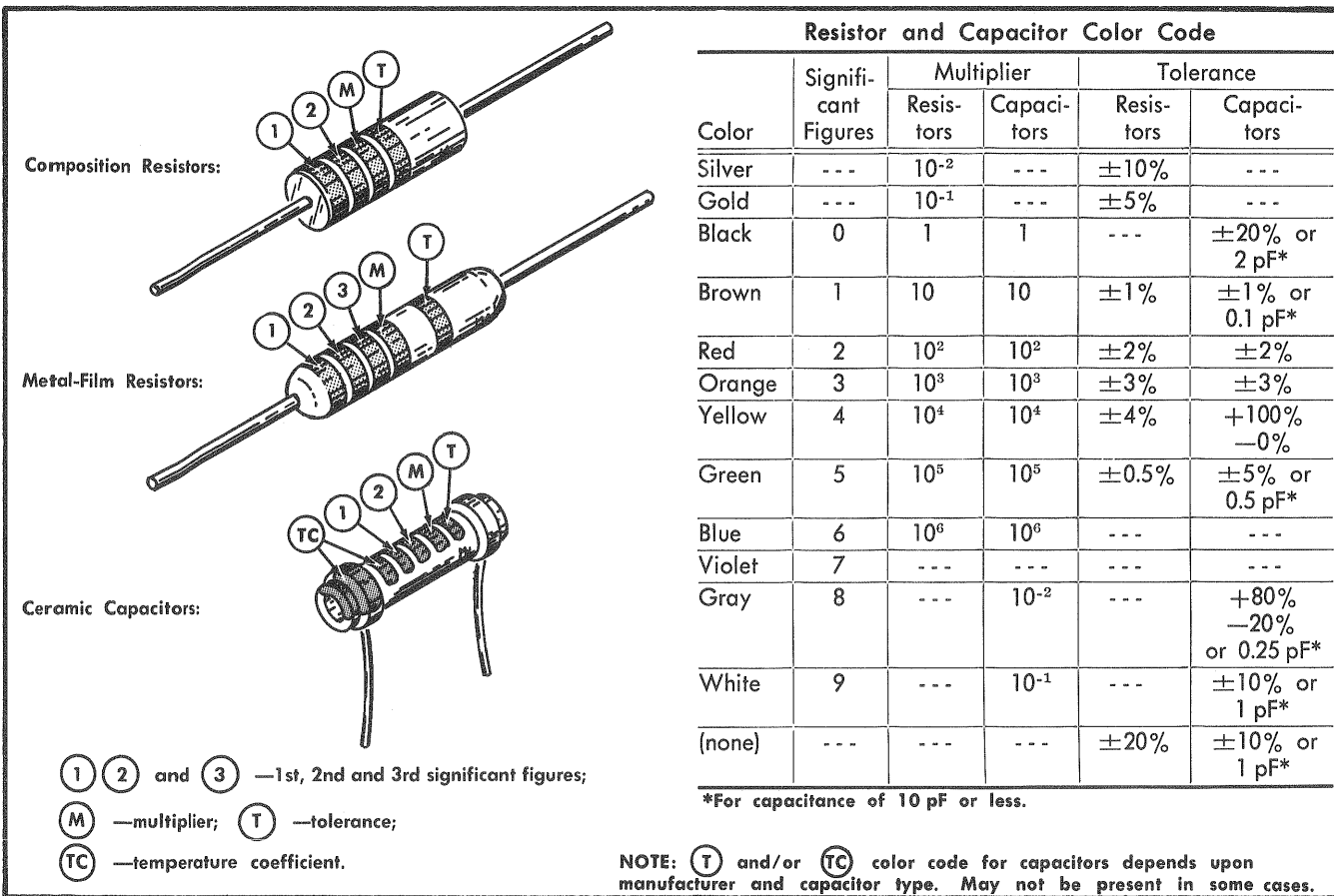

Fig. 4-3. Color-code for resistors and ceramic capacitors.

No output in DELAYED mode and no delayed pulse in PAIRED MODE would indicate trouble in the delay generator circuit.

3. Visually inspect the area or the assembly for defects such as broken or loose connections, improperly seated components, over-heated or burned components, chafed insulation or cracked insulators, etc. Repair or replace all obviously defective components. In the case of overheated parts, try to determine the cause of overheating and correct before applying power.

4. Check power supply voltages, then circuit voltages and waveforms. The schematic diagrams contain pertinent voltages and waveforms for this purpose. Component location and test points are shown on circuit board call out illustrations at the end of this sections (Fig. 4-8).

NOTE

Voltages and waveform illustrations on the diagrams are not absolute and may vary between instruments. The first diagrams page lists the conditions set to obtain the illustrations on the diagram.

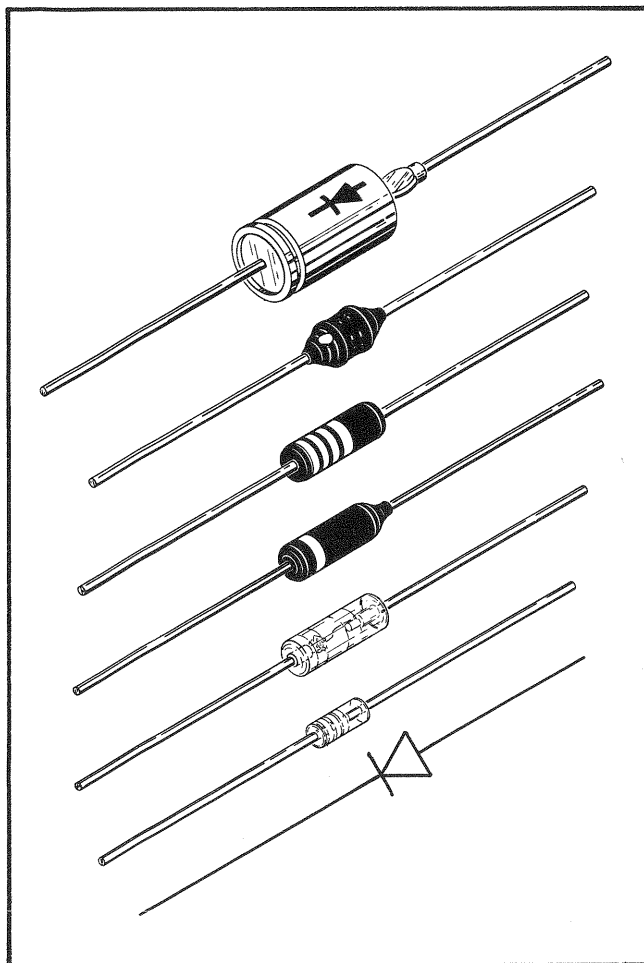

Fig. 4-4. Diode polarity markings.

CAUTION

When measuring voltages and waveforms, use extreme care in placing meter leads or probes. Because of high component density, and the limited access within the instrument, an inadvertent movement of the leads or probe can cause a short circuit, producing transient voltages that may destroy many components.

The outer conductors or shield of the coaxial leads from the MODE switch (white with orange and white with yellow tracers) are connected to —5.1 volts. Do not connect the ground lead of the test oscilloscope probe to these shields.

5. Check calibration adjustments of the affected circuit, if applicable. Before changing any adjustment, note its position so it can be returned to the original setting if adjustment has no effect on the trouble. This will facilitate recalibration after locating and repairing the trouble.

If trouble has not been found and corrected by the foregoing procedure, a more detailed analysis must be performed. The Circuit Description section describes the operational theory of each circuit and should aid in the evaluation of the problem.

Semiconductor failures account for the majority of electronic equipment failure. Because most semiconductor devices (transistors and IC's) are socket mounted, substitution is often the most practical means of checking their performance. The following guide lines should be followed when substituting these components.

1. Determine first that circuit voltages are safe for the substituted component so the replacement will not be damaged. (Refer to instruction on replacing transistors with heat dissipators under Corrective Maintenance).
2. Use only good components for substitution.
3. Turn the power off before a component is substituted.
4. Be sure the component is inserted properly in the socket (see Fig. 4-5).
5. Return good components to their original socket. This will reduce calibration time and run-in period.
6. Check calibration and performance after a faulty component has been replaced.

If a substitute is not available, check the transistor or FET with a dynamic tester such as the Tektronix Type 576 Curve Tracer.

Static type testers, such as an ohmmeter, can be used to check resistance ratios across semiconductor junctions if no other method is available. Use the high resistance ranges ($R \times 1$ k or higher) so the external current is limited to less than 2 mA. If uncertain, measure the external current with an ammeter. Resistance ratios across base-to-emitter or base-to-collector junctions usually run 100:1 or higher. The ratio is measured by connecting the meter leads across the terminals, noting the reading, then reversing the leads and noting the second reading.

Power transistors with cooling radiators or heat dissipators (e.g. Q270) use a silicone grease between the heat dissipator and the transistors case to increase heat dissipation. The

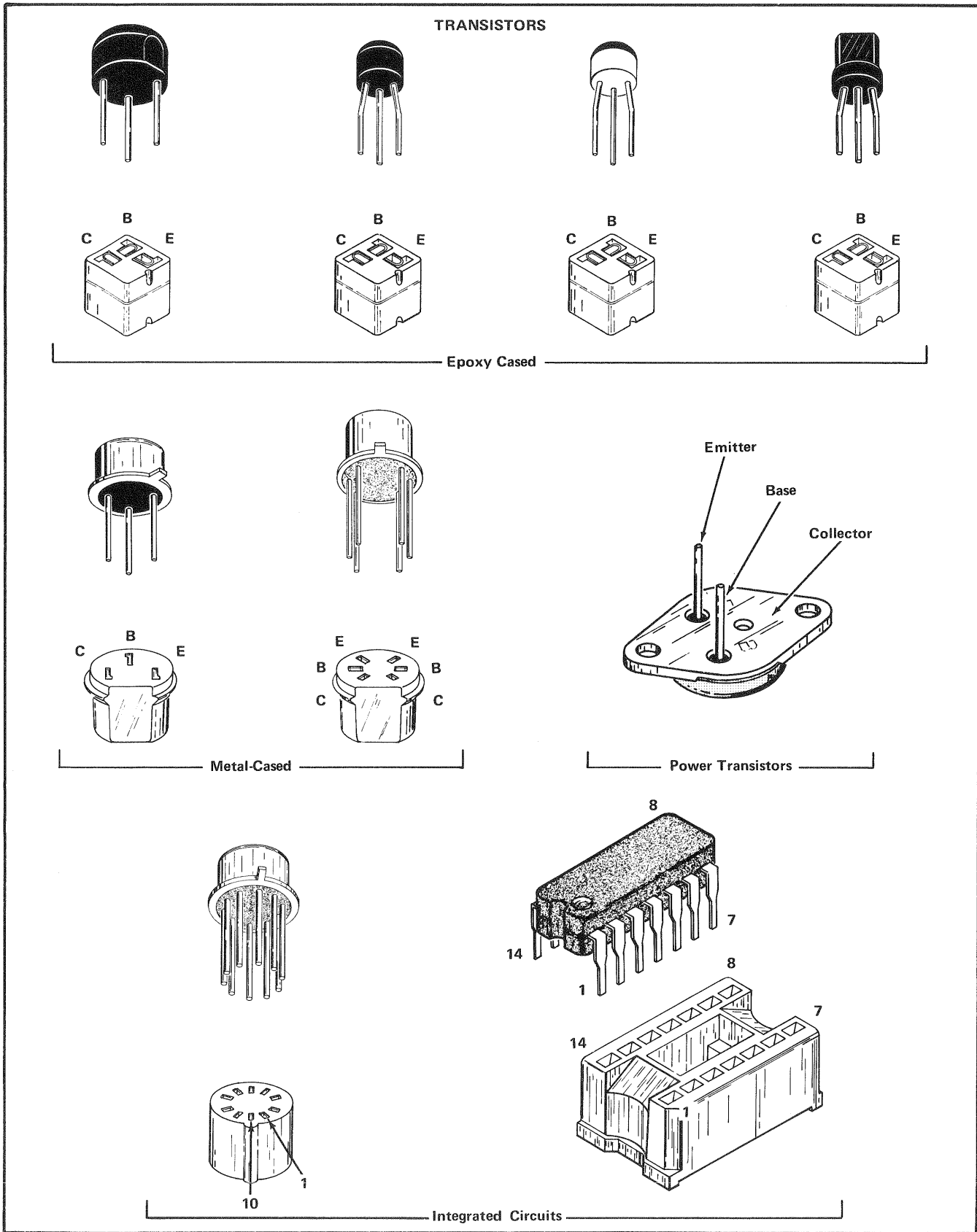

Fig. 4-5. Electrode configuration for socket mounted transistors.

Maintenance—2101

chassis mounted transistors (e.g. Q420, Q440) use silicone grease on both sides of the mica insulating washer. Replace the silicone grease when the transistors are replaced.

WARNING

Silicone grease can cause severe eye irritation. Wash hands thoroughly after use. If eyes become contaminated, thoroughly flush the grease away with warm water and consult a medical facility.

Diode Checks—Most diodes can be checked in the circuit by taking measurements across the diode and comparing these with the voltage listed on the diagram. Forward-to-back resistance ratios can usually be taken by referring to the schematic and pulling appropriate transistors and pin connectors to remove low resistance loops around the diode. If necessary, unsolder one end of the diode and lift it clear so the ratio can be taken. Observe suggested soldering practices (using a heat sink) when soldering or unsoldering the diode.

CAUTION

Do not use an ohmmeter scale with a high external current to check the diode junction. (See transistor checks.)

Integrated Circuit (IC) Checks—Integrated circuits are most easily checked by direct replacement. When substitution is impossible, check input and output signal states as described in the circuit description and on the diagram. Lead configuration and data for the IC's used in this instrument are provided by Fig. 4-5 and Fig. 4-6.

CORRECTIVE MAINTENANCE

Corrective maintenance consist of component replacement and instrument repair. Special techniques and procedures, required to replace components in this instrument, are described here.

Obtaining Replacement Parts

All electrical and mechanical parts replacement can be obtained through your local Tektronix Field Office or representative. Many of the standard electronic components, however, can be obtained locally in less time than that required to order from Tektronix, Inc. Before purchasing or ordering replacement parts, consult the Parts List for value, tolerance and rating. The Parts section contains instructions on how to order these replacement parts.

NOTE

When selecting the replacement parts, it is important to remember that the physical size and shape of the component may affect its performance in the circuit.

It is best to duplicate the original component as closely as possible. Parts orientation and lead dress should also duplicate those of the original part because some components are oriented to reduce or control circuit capacitance and inductance. After repair, the circuits of the instrument may need recalibration.

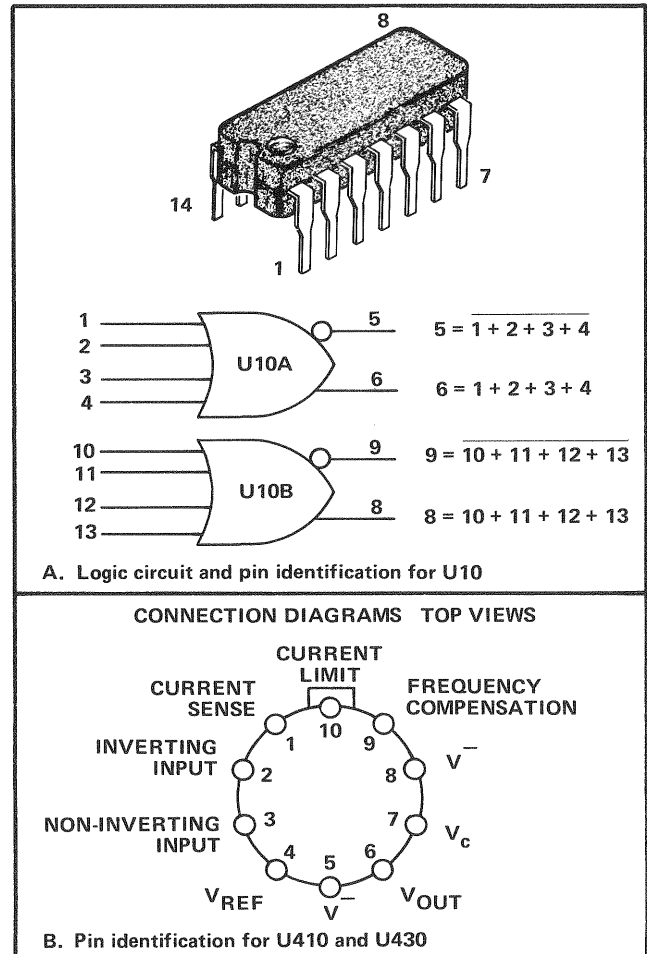

Fig. 4-6. Lead configuration and equivalent circuits for IC's used in the 2101.

Soldering Technique

WARNING

Disconnect the instrument from the power source before soldering.

Circuit Boards. Use ordinary 60/40 solder and a 35-to-40-watt pencil type soldering iron on the circuit boards. The tip of the iron should be clean and properly tinned for best heat transfer to the solder joint. A higher wattage soldering iron may separate the wiring from the base material. Most components can be replaced without removing the boards from the instrument.

The following procedure is recommended to replace a component on a circuit board.

1. Grip the component lead with long-nose pliers. Touch the soldering iron to the lead at the solder connection. Do not lay the iron directly on the board as it may damage the board.

2. When the solder begins to melt, pull the lead out gently. This should leave a clean hole in the board. If not, the hole can be cleaned by reheating the solder and placing a sharp

object such as a toothpick into the hole. A vacuum-type desoldering tool can also be used for this purpose.

3. Bend the new component leads to fit the holes in the board. If the board is mounted in the instrument, cut the leads so they will just protrude through the board. Insert the leads into the holes in the board so the component is firmly seated (or as positioned originally). If it does not seat properly, heat the solder and gently press the component into place.

4. Heat-sensitive components are protected by holding the lead between the component body and the solder joint with a pair of long-nose pliers or other heat sink. Touch the iron to the connection and apply a small amount of solder to make a firm solder joint.

5. Clip the excess leads (if not clipped in step 3) that protrude through the board.

6. Clean the area around the solder connection with a flux-remover solvent. Be careful not to remove information printed on the board.

Metal Terminal Soldering. When soldering metal terminals (e.g., switch terminals, potentiometers, etc.) ordinary 60/40 solder is satisfactory. The soldering iron should have a 40- to 75-watt rating and a $\frac{1}{8}$ inch chisel tip.

1. Apply only enough heat to make the solder flow freely and form a good electrical connection. Do not use excessive solder. Excess solder may impair the operation of the circuit or cover a cold solder joint.

2. Clip off excess wire that may extend past the soldered connection and clean the area with flux-remover solvent.

Replacing the Circuit Board

Most of the components on the circuit board can be replaced without removing the board. Observing the soldering precautions outlined under Soldering Technique. The following procedure should be followed to remove the circuit board.

1. Remove the knobs from the PERIOD, PULSE DURATION, and DELAY selectors; then the knobs from the PULSE DURATION, and DELAY VARIABLE controls.

2. Disconnect all the multi-pin connectors to the circuit board pin connectors.

3. Unsolder all soldered lead connections on the bottom of the circuit board.

4. Unsolder the lead connections from the four parallel, 100 Ω , resistors to the 50 Ω INTERNAL TERMINATION switches, at the switch terminals. (Fig. 4-7).

5. Remove the board mounting screws. (Eleven total, five on each side plus one at the back.)

6. Remove the two screws on each side of the front panel that hold the front panel casting to the side rails.

7. Slip the front panel casting forward to clear the cam switches and control shafts.

8. Lift the circuit board out of the instrument.

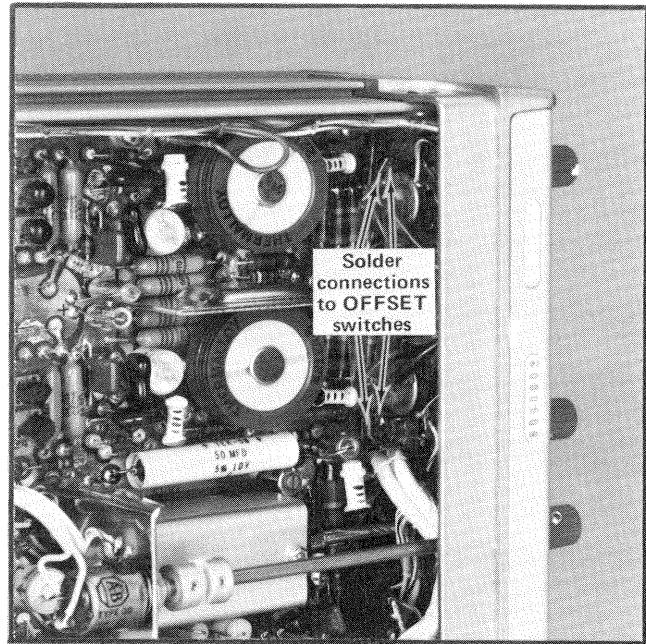

Fig. 4-7. Soldered connection of the four 100 Ω circuit board resistors to 50 Ω INTERNAL TERMINATION switches. Disconnect to remove circuit board.

9. Reverse the removal procedure to install a replacement board.

CAUTION

Refer to instructions on replacing PERIOD-PULSE DURATION knobs before turning POWER switch ON.

Replacing Transistors with Heat Dissipators

The heat dissipators for transistors Q252-Q254 or Q352-Q354 are mounted, by two screws, to the circuit board. These transistors are removed or replaced as follows:

1. Remove the two screws that secure the heat sink to the circuit board.

2. Pull the transistor out of its socket.

3. Unscrew the plastic insert and lift the transistor out of the heat sink body.

4. Reverse the removal procedure to replace the transistor.

Replacing the Square Pin Circuit Board Pins

It is important not to damage or disturb the ferrule when removing the old stub of a broken pin. The ferrule is swaged into the circuit board and provides a base for soldering the pin connector.

If the broken stub is long enough, grasp it with a pair of needle nose pliers, apply heat with a small soldering iron to the pin base or the ferrule and pull the old pin out. (The pin is pressed into the ferrule, so a firm pull is required to pull it out.)

If the broken stub is too short to grasp with pliers, use a small dowel (.028 inches in diameter) clamped in a vise to push the pin out of the ferrule after the solder has been heated.

The old ferrule can be cleaned by reheating the solder and placing a sharp object such as a toothpick or small dowel into the hole. A 0.031 drill mounted in a pin vise may also be used to ream the solder out of the old ferrule.

Use a pair of diagonal cutters to remove the ferrule from the new pin, then insert the pin into the old ferrule, and solder the pin to both sides of the ferrule.

If it is necessary to bend the new pin, grasp the base of the pin with needle nose pliers and bend against the pressure of the pliers to avoid breaking the board around the ferrule.

Replacing PERIOD-PULSE DURATION Selector Knobs

The period and duration timing circuit share common timing capacitors, therefore the cam switches must be positioned so the two circuits are not connected across the same capacitor at the same time. Replace the selector knobs as follows:

1. Disconnect the unit from the power source to prevent accidentally switching the POWER switch ON.

2. Turn both switches fully clockwise.

3. Install the PERIOD selector knob so the index points to the  position and tighten the set screw. Rotate the switch through all positions to ensure the knob is indexed properly, then return the switch to its fully clockwise position.

4. Install the DURATION selector knob so its locking pin is engaged into the PERIOD knob coupling slot and its index points to the  position. Be sure the locking pin is engaged and the knob is seated against the PERIOD knob. Tighten the set screw and rotate the selector through all positions to check the knob position.

5. The power may now be connected to the instrument.

Cam Switch Repair or Replacement

CAUTION

Because the alignment and spring tension of the cam switch contacts are critical and must be carefully maintained for proper operation, the repair of these switches should be undertaken only by experienced maintenance personnel. A cam-type switch repair kit, including replacement contacts, alignment tools, and instructions is available from Tektronix, Inc. Order Part No. 040-0541-00. If assistance is desired, contact your local Tektronix Field Office or representative.

The cam switch consists of a rotating cam and a set of contacts mounted on the adjacent circuit board. These switch contacts are actuated by lobes on the cam. The

PERIOD DURATION, and DELAY cam switches can be disassembled for inspection, cleaning, repair or replacement as follows:

REMOVAL PROCEDURE

DELAY SWITCH

1. Remove shaft and coupler from delay variable pot, by loosening the two set screws, and slide forward.

2. Remove the variable pot.

3. Remove shaft from delay switch by loosening set screws.

4. Unsolder ground strap from terminal under cover screw.

5. Remove four (4) screws under board and remove cam switch.

PULSE DURATION/PERIOD Switch

1. Remove knobs.

2. Remove six (6) screws on underside of board.

3. Remove cam switch.

ASSEMBLY PROCEDURE

DELAY SWITCH

1. Install switch assembly and secure with four (4) screws on underside of board.

2. Solder ground strap to terminal under cover screw.

3. Install switch shaft.

4. Install variable pot.

5. Install variable pot shaft and coupler.

PULSE DURATION/PERIOD Switch

1. Install cam switch.

2. Secure with six (6) screws.

3. Install knobs (see instructions on replacing knobs). Do not apply power until knob and switch positions have been checked.

Miscellaneous Maintenance Information

The power transformer in this instrument is warranted for the life of the instrument. If defective, contact your local Tektronix Field Office or representative for replacement (see Warranty note in the front of this manual). Use only a direct replacement Tektronix transformer. Be sure to label the leads as they are unsoldered from the transformer terminals. If the thermal cutout (S402) is replaced, be sure the nuts and bolts used to mount the cutout switch are tight before switching the instrument power on.

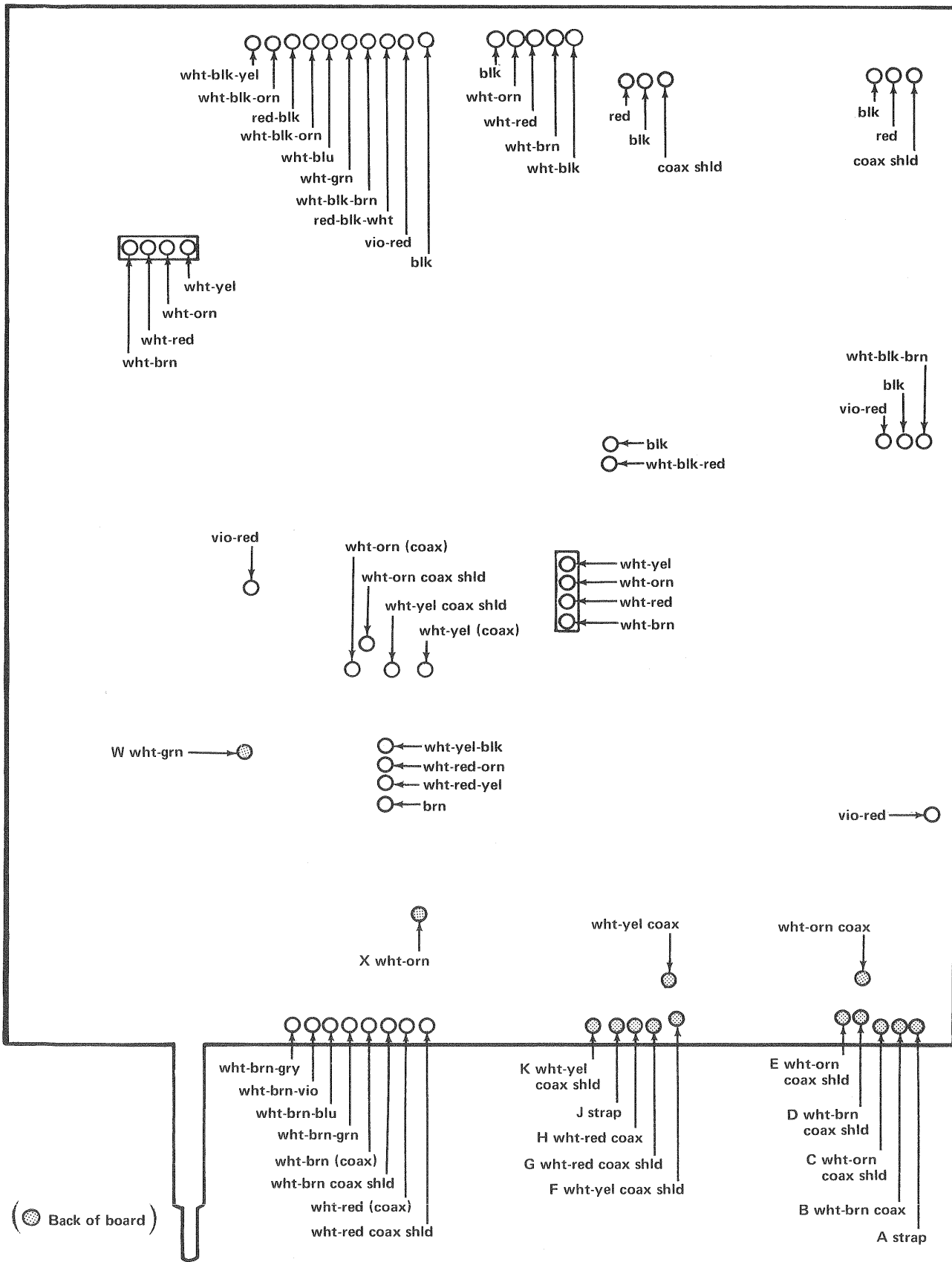

Fig. 4-8B. Location of pin connectors and wire color code to connectors.

SECTION 5

PERFORMANCE CHECK / CALIBRATION

Change information, if any, affecting this section will be found at the rear of the manual.

Introduction

This section is a composite of two procedures: It consists of complete information for performing a front panel check of the instrument performance against specifications outlined in Section 1 of this manual and a complete calibration procedure for the instrument. By performing the complete procedure the instrument is checked and restored to its original performance standards. The equipment recommended listed are needed for both the Performance Check and Calibration procedure. Equipment setup pictures, control settings, and most waveform photographs apply to both procedures.

Limits, tolerances and waveforms provided in the calibration steps are furnished as guides or aids to calibrating the instrument. They are not intended as instrument specifications. For example: The power supply voltages and ripple tolerances are operational guides to obtain optimum instrument operation, actual values may exceed the listed tolerances with no loss in instrument performance.

Complete or Partial Performance Check

If a complete performance check is desired, perform all steps, in sequence, that do not require removing the side panels or covers. The performance requirements given in this section correspond to the characteristics given in the Specification section of the manual. Internal calibration adjustment steps and checks are preceded with ADJUST. These steps are not part of the performance check procedure and should be ignored.

If a partial performance check is desired, refer to the nearest test equipment setup that precedes the desired check step for the initial equipment setup and control positions. Make the necessary setup and control position changes, described in the steps between initial setup and the desired partial check, then perform the check.

Complete or Partial Calibration

Before performing a complete calibration, the instrument should be cleaned and inspected as outlined in the Maintenance Section. Perform all checks and adjustments in sequence for a complete calibration. Internal checks, such as power supply regulation, are preceded or followed by a NOTE to indicate these checks are only applicable to calibration.

Because some circuits in this instrument are inherently stable, and some circuits and assemblies require extensive facilities with expensive test equipment to be calibrated a partial calibration may be desirable. A partial calibration is performed by turning to the check or calibration steps desired. Prepare the instrument by referring to the nearest preceding setup figure and control setup chart for the initial setup.

History Information

Because the instrument and manual are subjected to a program of constant evaluation and updating, circuits are modified along with their performance/calibration procedures. The history procedure and information applicable to earlier instruments are included either as deviations within the steps or as a subpart of a step. These are clearly indicated.

Interaction

Adjustments that interact are noted and reference to the affected step or steps indicated.

Equipment and Test Fixtures Required and Recommended

The following list of equipment is required to perform a complete performance check or calibration. Specifications given are minimum requirements for accurate calibration. Some of the recommended equipment specifications may exceed requirements, however substitute equipment must meet or exceed minimum specifications.

Special Tektronix calibration fixtures are used to facilitate the procedure. These fixtures are available from Tektronix, Inc. and may be ordered through your local Tektronix Field Office or representative.

If a partial performance check or partial calibration is desired, the necessary equipment to perform these checks and adjustments can be determined by referring to the appropriate steps in the procedure.

In some cases, a compromise may be made when the equipment required to check or verify a high tolerance specification is expensive or impractical to obtain. Notification of the compromise is made as a footnote to the equipment list along with a statement that the high tolerance specifications cannot be checked because of the compromise.

Performance Check/Calibration—2101

1. Test Oscilloscope, real time: Risetime 5 ns or less, dual trace vertical mode, time-base sweep rate to $.05 \mu\text{s}/\text{division}$. Tektronix Type 454, or 7704 with 7A12 and 7B71.

2. Test Oscilloscope, sampling: Equivalent risetime 350 ps, transient response $\pm 2\%$, or less aberrations, dual trace vertical mode, time/division to 5 ns. Tektronix Type 561B or 564B, with Type 3S1 and 3T77A plug-in units; or the Type 540 series with 1S1 plug-in unit.

3. Probe $1\times$: Tektronix P6011 with BNC connector (for real time oscilloscope) Tektronix Part Number 010-0193-00.

4. Probe $100\times$: Tektronix P6053 with GR connector (for sampling unit). Tektronix Part Number 010-0111-00.

5. Variable Autotransformer: Output voltage range 90 volts to 136 volts RMS AC for 115 volt operation or 180 volts to 272 volts RMS AC for 230 volt operation; output power rating. If monitor voltmeter is not included, separate AC voltmeter is required. General Radio, Variac Type W10MT3W.

6. Pulse Generator: 50 ohm source impedance, variable pulse amplitude output to 5V peak. Tektronix 2101 Pulse Generator.

7. Time-Mark Generator: Markers from 5 s to 5 ns, trigger output from 1 s to $.1 \mu\text{s}$, amplitude at least 1 volt into 50Ω , marker accuracy within $.001\%$. Tektronix 2901 Time Mark Generator.

8. DC Voltmeter: Voltage range 5 volts to 20 volts, accuracy within 1% at 5V, 10V and 20V, sensitivity 20,000 ohms/volt.

9. Two coaxial 5 ns cables: Impedance 50Ω , GR connectors. Tektronix Part Number 017-0502-00.

10. Three 42 inch coaxial cables: Impedance 50Ω , BNC connectors. Tektronix Part Number 012-0117-00 (Part of 2101 accessories).

11. Two $10\times$ attenuators: 50Ω , GR connectors, frequency to 1 GHz, power rating 1 watt. Tektronix Part Number 017-0078-00.

12. Two $10\times$ attenuators: 50Ω BNC connectors, frequency to 250 MHz, power rating 2 watts. Tektronix Part Number 011-0059-01.

13. Two feedthrough terminations: 50Ω , 5 watt, BNC connectors, frequency to 250 MHz. Tektronix Part Number 011-0099-00 (Part of 2101 accessories).

14. Two adapters: BNC male to GR. Tektronix Part Number 017-0064-00.

15. Adapter: BNC T connector. Tektronix Part Number 103-0030-00.

16. Coupling capacitor: GR connector. Tektronix Part Number 017-0028-00.

PERFORMANCE CHECK/CALIBRATION RECORD AND INDEX

The following abridged performance check and calibration procedure provides a record of the performance check and/or calibration. It may also serve as a guide for the experienced calibrator, or an index to the procedure to locate desired steps within the procedure. Requirements given in this short form correspond to those given in Section 1 of the manual.

Short Form Procedure



2101, Serial No. _____

Calibration Date _____

Calibrator _____

- 1. Adjust +20-volt Supply (Calibration only) Page 5-4
Requirement: $+20 \text{ V} \pm 0.25 \text{ V}$
- 2. Adjust -20-volt Supply (Calibration only) Page 5-5
Requirement: $-20 \text{ V} \pm 0.25 \text{ V}$
- 3. Check -10.1-volt, -5.1-volt, +5.1-volt, and +6.2-volt supplies. (Calibration only) Page 5-5
Requirement: Check within 0.25 V.
- 4. Check Power Supply Regulation and Ripple Page 5-5 (Calibration only)
Requirement: Ripple amplitude 10 mV or less over the regulating range of the power supply.
- 5. Adjust Pulse Generator Trigger Level Page 5-6 (Calibration only)
Requirement: Adjust R75 for optimum square wave output pulse at PRETRIG OUT connector.
- 6. Adjust UNDLY'D and DELAYED Trigger Sensitivity (Calibration only) Page 5-7
Adjust R155 and R89, clockwise from a counter-clockwise position, for an undelayed and delayed pulse for all positions of the PERIOD selector.
- 7. Check/Adjust Pulse Period and Duration Page 5-9
Requirement: Pulse period and duration must be within 5% of that indicated by the selector plus 3 ns.
Check—Accuracy of period and duration using Table 5-2.
Adjust—Period and duration as directed in Table 5-3.
Check—Range and VARIABLE controls for period and duration.

8. Check/Adjust Delay Accuracy Page 5-11
Requirement—Delay must be within 5% of that indicated by the DELAY selector plus 3 ns. Range of the VARIABLE control must exceed $20\times$.
Check—Accuracy of delay using Table 5-4 as guide.
Adjust—Delay accuracy using Table 5-4.
Check—Range of VARIABLE control.
9. Check Duty Factor Page 5-12
Requirement: Duty factor must equal or exceed 80% when period is 100 ns or more.
10. Check Paired Pulse Separation Page 5-13
Requirement: Minimum separation between pulse pairs must equal 20 ns or 20% of pulse duration $\pm 5\%$, whichever is greater.
11. Check Pulse Modes of Operation Page 5-13
Check—UNDLY'D, DELAYED, PAIRED, and OUTPUT LOCKED ON modes of operation.
12. Check Gated Mode of Operation Page 5-14
Requirement: Input gate amplitude 1 V to 3 V.
Reset level +50 mV or less.
Frequency range, to 25 MHz.
13. Check External Trigger Operation Page 5-15
Input trigger amplitude 1 V to 3 V, frequency to 25 MHz, reset level +50 mV. Delay between input trigger signal and output pulse must not exceed 60 ns.
14. Check/Adjust Pulse Shape (Preshoot, Overshoot, Rounding, and Pulse Top Flatness). Page 5-16
Requirement: Pulse aberrations (Preshoot, overshoot, ringing, etc.) must not exceed 3% of pulse amplitude or 100 mV whichever is greater.
Adjust—C243, C244, C343, and C344 for optimum pulse shape.
15. Check Pulse Risetime and Falltime Page 5-17
Requirement: Pulse rise and falltime must not exceed 5 ns.
16. Check Output Pulse Coincidence Page 5-17
Requirement: Coincidence of the two output pulses must be within 2 ns of each other.
17. Check Pulse Amplitude Range Page 5-17
Requirement: Pulse amplitude range into 50 Ω load must equal 200 mV or less to 10 V or more.
18. Check Baseline Offset Range Page 5-18
Requirement: Offset range must equal or exceed + and -2-volt into 50 Ω load.

19. Check PRETRIG Lead Time and Amplitude Page 5-18
Requirement: Lead time must equal or exceed 20 ns. PRETRIG OUT signal amplitude must equal or exceed 1-volt into 50 Ω load.
20. Check Internal Source Resistance Page 5-19
Requirement: OUTPUT terminal source resistance must equal or exceed 1500 Ω with 50 Ω INTERNAL TERMINATION out. Source resistance must equal 50 $\Omega \pm 2.5 \Omega$ with the 50 Ω INTERNAL TERMINATION in.
21. Check Limit for Output Pulse Amplitude Page 5-20
Requirement:  OUTPUT must limit at +21 V and -20 V.
 OUTPUT must limit at -21 V and +7 V.

Preliminary Procedure

The sequence of this procedure is arranged so the 2101 can be calibrated or checked with the least interaction of adjustments and reconnection of equipment. The adjustment steps are identified by the symbol  following the title. Instrument performance is checked in the "CHECK" part of the step before an adjustment is made. The "ADJUST" part of the step identifies the point at which the actual adjustment is made.

Test equipment setup pictures precede each group of similar steps to show the necessary equipment for each group of steps. Control settings and equipment setups throughout the procedure follow from the preceding step(s) unless noted otherwise. Front panel control titles that pertain to the 2101 are capitalized (e.g. PERIOD) in the procedure, Internal adjustments and test equipment control callouts are initial capitalized (e.g. -20 V Adjust, Time/Div).

The performance of the 2101 can be checked within an ambient temperature of 0°C to 50°C provided the instrument has had a warmup period of 30 minutes to stabilize. Calibrate the instrument within an ambient temperature of 25°C $\pm 5^\circ\text{C}$ for best performance.

All waveform illustrations in this procedure are actual photographs taken with a Tektronix Oscilloscope Camera System. These pictures are intended to help clarify written descriptions within the steps and are not adjustment objectives. Circuit modifications and variations between instruments can affect the waveform shape, making it impractical to duplicate the photograph in the manual.

Performance Check Only

1. Set the Voltage Selector assembly (rear panel) to the appropriate settings for the available power source (see Operating Instructions). Plug the 2101 power cord into the power source and turn the power switch on. Allow 30 minutes with power applied for the instrument to stabilize.
2. Begin the performance check with step 5 when performing a complete check, or turn to the desired check.
3. Terminate the unused OUTPUT connector into 50 Ω .

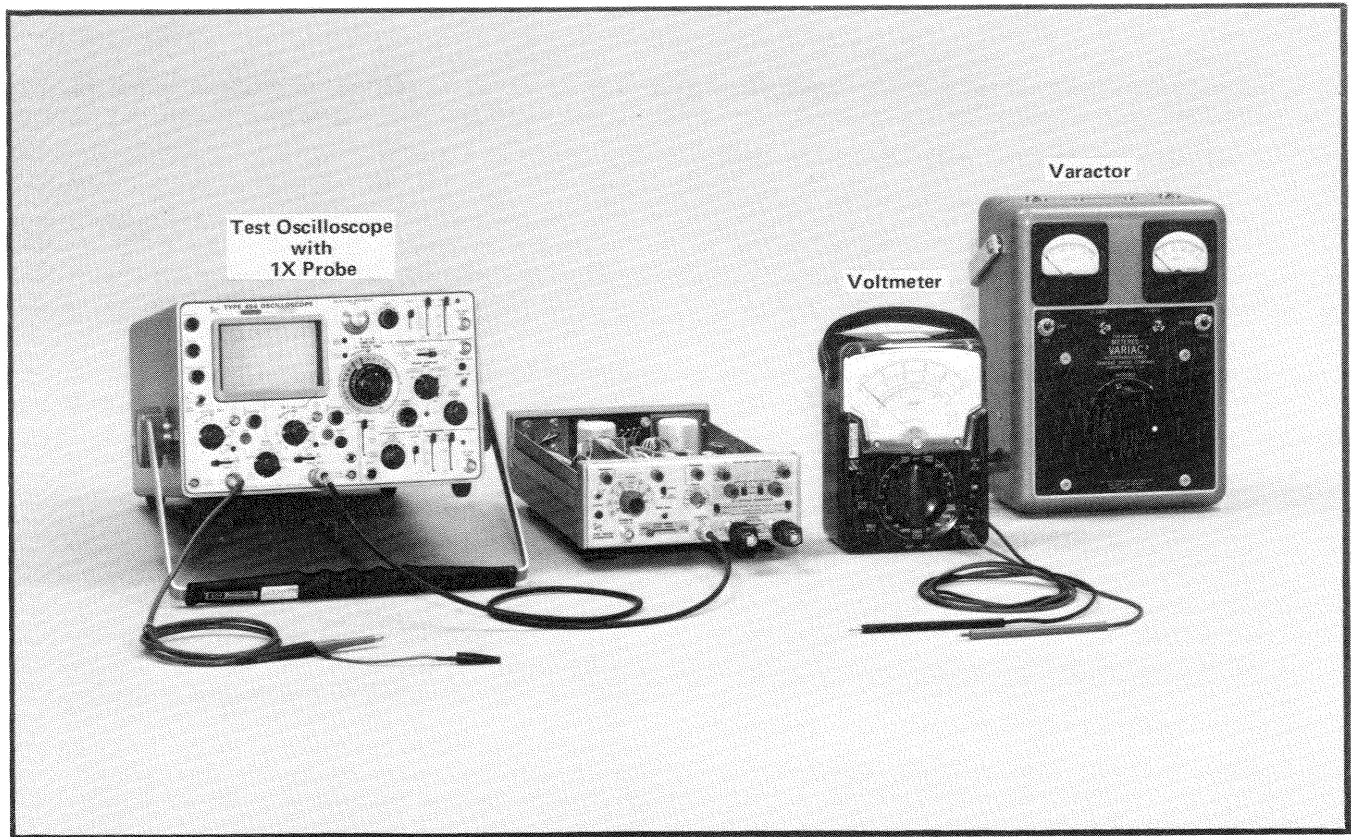

Fig. 5-1. Test equipment setup to check/adjust power supply and pulse triggering. (Steps 1-5)

Calibration Procedure Only

1. Remove the top and bottom covers from the 2101 Pulse Generator.
2. Connect the autotransformer to a suitable power source.
3. Set the Voltage assembly (on the back panel) for the correct line voltage operating range.
4. Connect the 2101 power cord into the output connector of the autotransformer. Set the voltage output of the autotransformer to 155 V (230 V).
5. Terminate the unused OUTPUT connector into 50 Ω.
6. Allow 30 minutes with power applied for the circuits to stabilize before making any adjustments.
7. Begin the calibration procedure as described for the desired step.

POWER SUPPLY

Power supply voltages and ripple tolerances called for in these adjustments are maintenance guides and not performance requirements. Actual voltage values can vary outside these listed tolerances with no adverse effects on the instru-

ment performance. Changing voltage levels may affect the calibration of some circuits, therefore performance should be checked if any of the voltage levels are changed.

Control settings for steps 1-4

2101

PULSE MODE	UNDLY'D
PULSE DURATION	2 ms
PERIOD	4 ms
DELAY	20 ns
PULSE AMPLITUDE (+ and -)	5
BASELINE OFFSET	OFF
50 Ω INTERNAL TERMINATION	IN (Connect 50 Ω termina- tion on the unused OUT- PUT).

1. Adjust +20-volt Supply

- a. Equipment setup is shown in Fig. 5-1.
- b. Position the 2101 so the top of the circuit board is exposed.

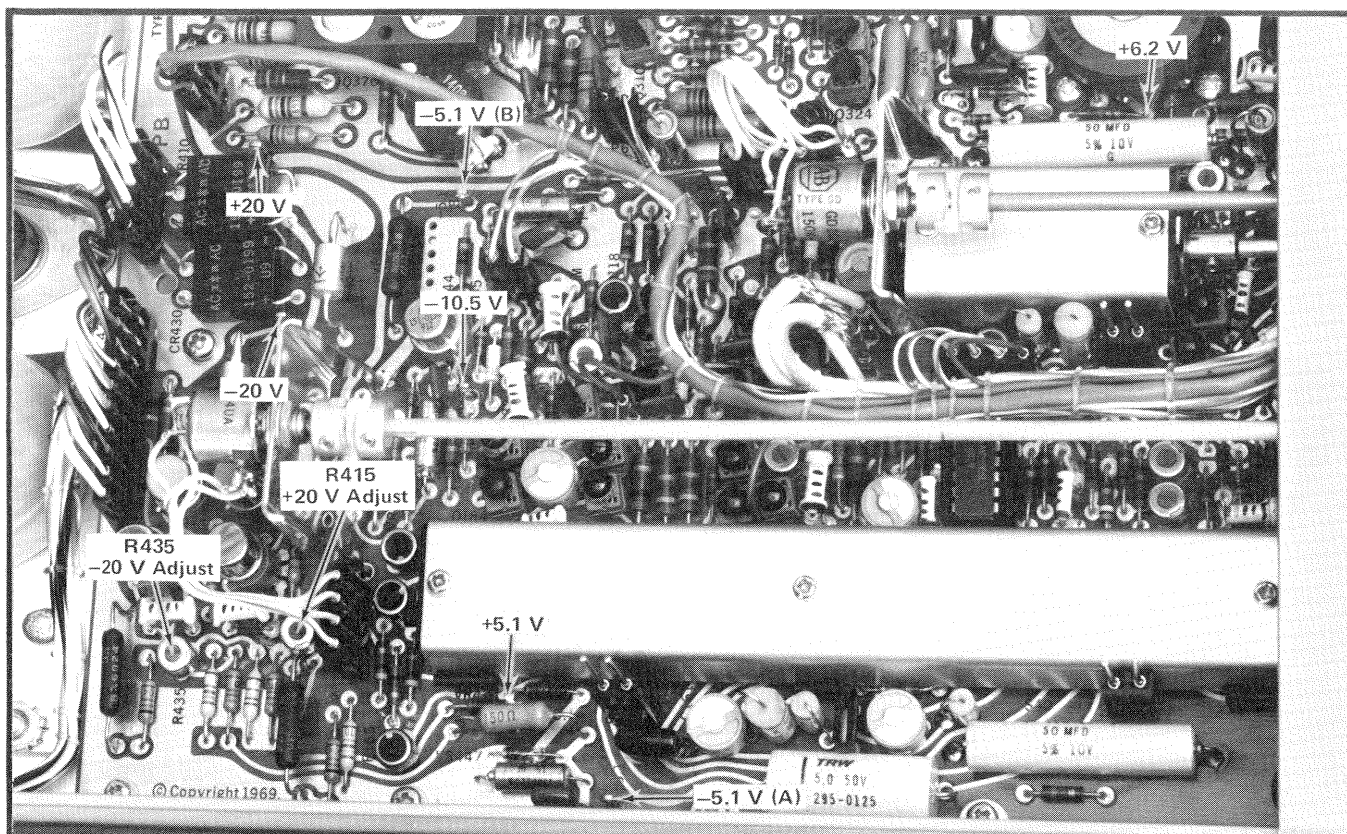

Fig. 5-2. Regulated power supply voltage adjustments and test points.

c. Connect the DC voltmeter between the +20-volt test point and chassis ground. See Fig. 5-2.

d. ADJUST—+20-volt adjust R415, (Fig. 5-2) for +20 volts ± 0.2 -volt.

2. Adjust -20-volt Supply



a. Equipment setup is given in step 1.

b. Connect the DC voltmeter between the -20-volt test terminal and chassis ground (Fig. 5-2).

c. ADJUST—20 volts adjust R435, (Fig. 5-2) for -20 volts ± 0.2 -volt.

3. Check -10.1 V, -5.1 V, +5.1 V and 6.2 V Supplies.

a. Connect the DC voltmeter between the -10.5 Volt test point and chassis ground (Fig. 5-2).

b. Check for -10.1-volt ± 0.5 -volt.

c. Connect the DC voltmeter between the -5.1 (A) volt test point and chassis ground. (See Fig. 5-2).

d. Check for -5.1 V ± 0.25 V.

e. Connect the DC voltmeter between the -5.1 (B) volt test point and chassis ground. (See Fig. 5-2).

f. Check for -5.1 V ± 0.25 V.

g. Connect the voltmeter between +5.1-volt test point and chassis ground.

h. Check for +5.1 V ± 0.25 V

i. Connect the voltmeter between the +6.2 Volt test point and chassis ground. (See Fig. 5-2).

j. Check for 6.2 V ± 0.25 V

4. Check Power Supply Regulation and Ripple Content

a. Test equipment setup is shown in Fig. 5-1.

b. Trigger the test oscilloscope in line frequency. Connect a 1 \times probe to the power supply test points that are listed in Table 5-1 and shown in Fig. 5-2.

c. Check the oscilloscope display for power supply ripple. Vary the autotransformer output voltage over the regulating range of that selected by the Line Voltage Selector assembly on the back panel. Ripple amplitude must not exceed 10 mV over the regulating range of the power supply.

d. Disconnect the 2101 from the autotransformer and connect the power cord directly to a power source, or set the output voltage of the autotransformer to the center of the regulating range selected by the Line Voltage Selector assembly.

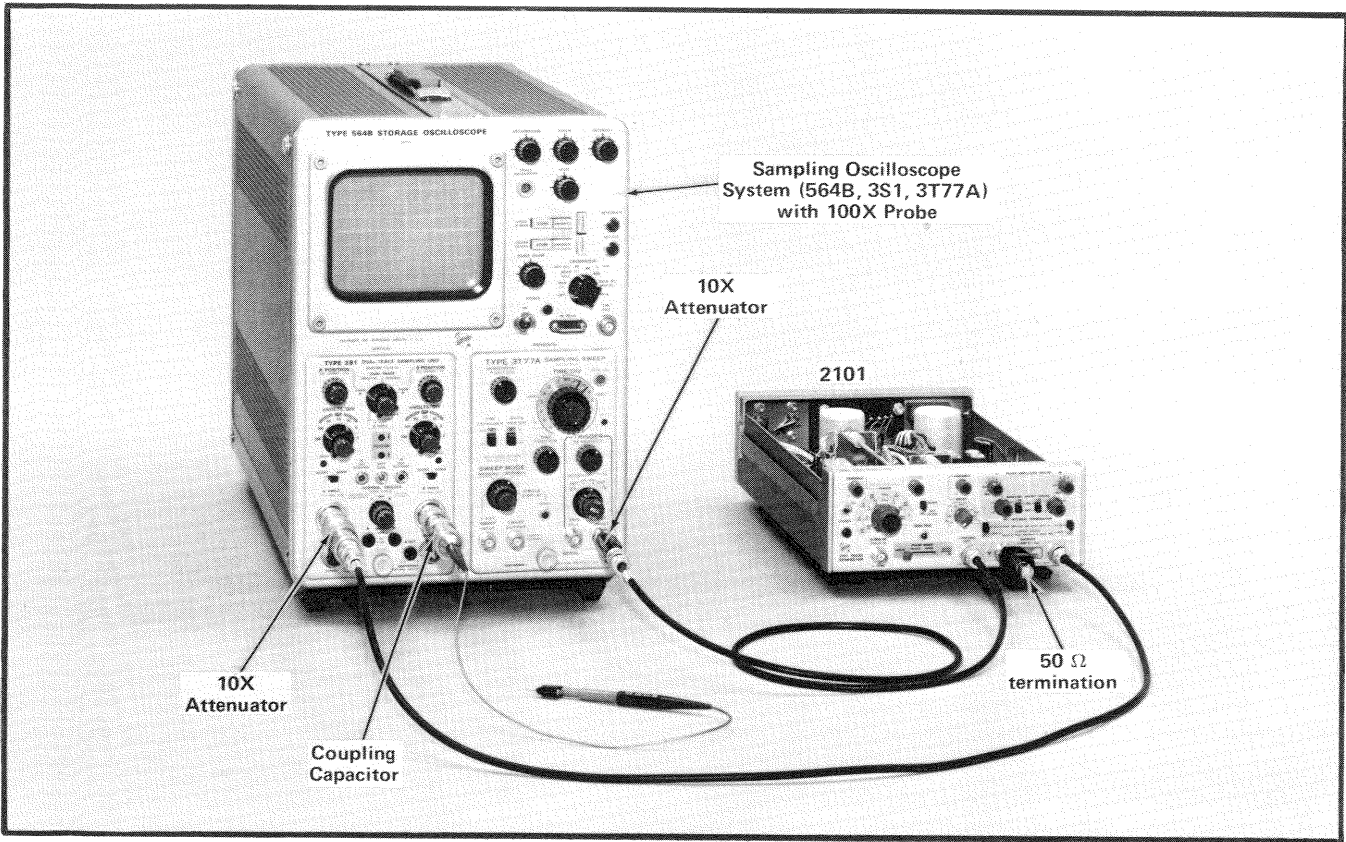

Fig. 5-4. Test equipment setup to check/adjust UNDLY'D and DELAYED trigger sensitivity.

2101

PULSE MODE	UNDLY'D
NORM-EXT GATED	NORM
PERIOD	40 ns
VARIABLE	1X
PULSE DURATION	20 ns
VARIABLE	1X
DELAY	20 ns
VARIABLE	1X
PULSE AMPLITUDE (+ and -)	10
BASELINE OFFSET (+ and -)	OFF
50 Ω INTERNAL TERMINA- TION (+ and -)	IN

Test Oscilloscope

Time/Div	10 ns
Volts/Div	100 mV
Delay	20 ns
Triggering	+ Ext

6. Adjust UNDLY'D and DELAYED Trigger Sensitivity

- a. Equipment setup is shown in Fig. 5-4. ①
- b. Apply the + PRETRIG OUT signal through a 10X attenuator to the Ext Trig Input of the test oscilloscope. Apply the OUTPUT through a 50 Ω coaxial cable and 10X attenuator to one vertical input of a sampling unit.
- c. CHECK—The display for an output pulse. Adjust PULSE AMPLITUDE or the test oscilloscope vertical sensitivity for a pulse amplitude of 4 divisions.
- d. ADJUST—The duration circuit sensitivity by adjusting R155 (Fig. 5-5) clockwise from a counterclockwise position until an output pulse is displayed, then advance the adjustment about 10 degrees for stable triggering. Adjustment should be set between the free running state and initial trigger state.

NOTE

If a pulse output cannot be obtained, connect a 100X probe through a coupling capacitor (Part No. 017-0028-00) to the vertical input of the sampling unit. Connect the probe tip to the base of Q156 (Fig. 5-5). Adjust R155 for a positive-going pulse at the base of Q156 (see Fig. 5-6).

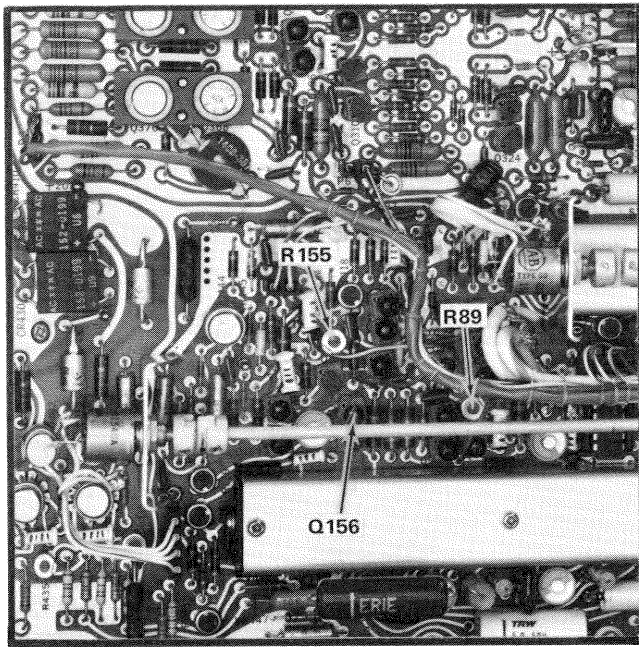

Fig. 5-5. Location of undelayed and delayed trigger sensitivity adjustments.

- e. Switch the PULSE MODE selector to DELAYED position and the PERIOD to .4 μ s.
- f. CHECK—The display for a delayed output pulse.
- g. ADJUST—The delay circuit trigger sensitivity by adjusting R89 (Fig. 5-5) clockwise from a counterclockwise position until the delayed pulse output is displayed.

NOTE

If an output pulse cannot be obtained, use the same procedure, described in the note preceding (e) above.

- h. Switch the PULSE MODE selector to PAIRED position. Adjust the DELAY VARIABLE clockwise about 10°.
- i. CHECK—Display should contain two pulses separated from each other approximately 60 ns (see Fig. 5-7). Adjust the DELAY VARIABLE to separate the two pulses (20 ns minimum separation). The pulse duration of the undelayed and delayed pulse should be the same.
- j. ADJUST—R89 until the delayed pulse duration equals the undelayed pulse duration.
- k. CHECK—The circuit operation by switching the DURATION-PERIOD selectors through their range. The paired pulse output must remain over all sections.

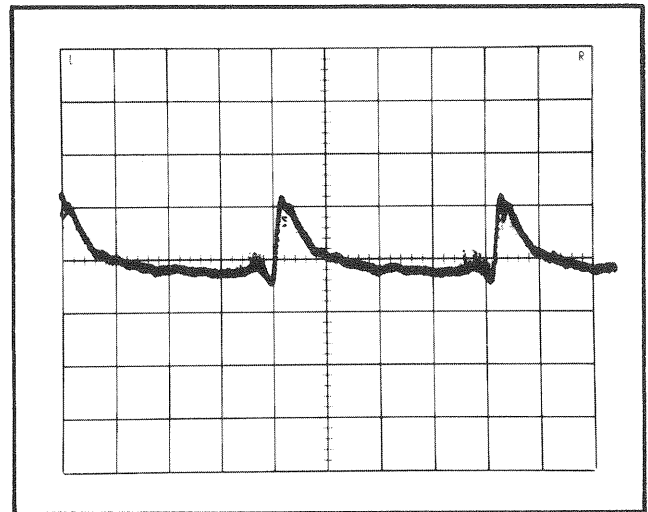

Fig. 5-6. Typical pulse shape of the trigger pulse at the base of Q156.

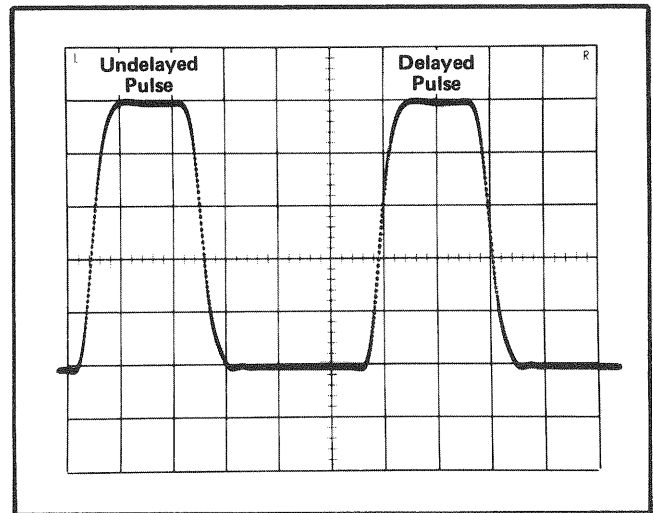

Fig. 5-7. Display of undelayed and delayed pulse pairs when checking trigger sensitivity. Pulse duration for the pulses should be equal.

- l. ADJUST—R155 and R89 until the paired pulses are displayed for all selections of DURATION and PERIOD. Return the DURATION to 20 ns and recheck duration of both the undelayed and delayed pulse to insure that they are equal.

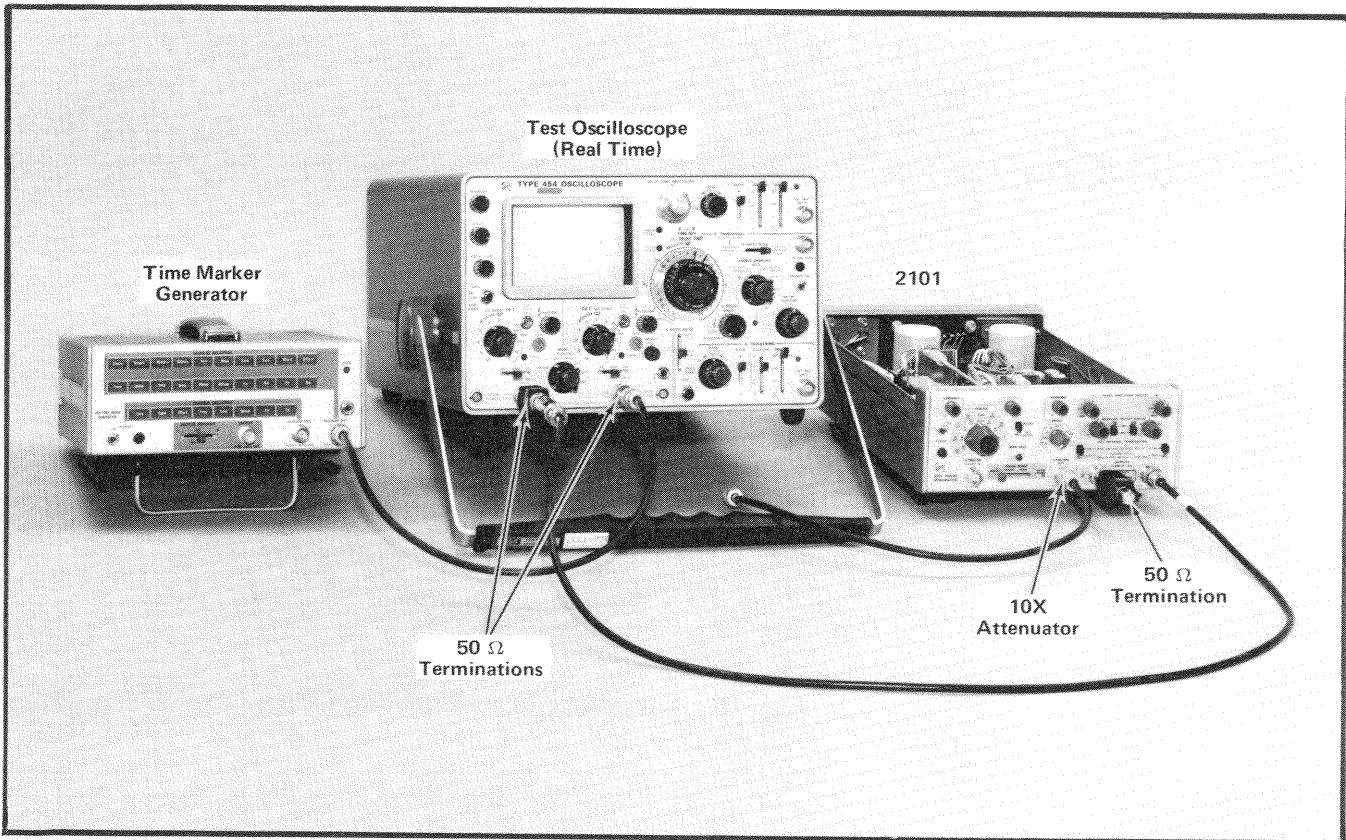

Fig. 5-8. Test equipment setup to check/adjust pulse PERIOD, DURATION and DELAY accuracy; also check duty factor, pulse separation, and operating modes. (Steps 7 through 12)

Control Settings for Fig. 5-8, Step 7

2101		Test Oscilloscope	
PULSE MODE	UNDLY'D	Time/Div	.1 ms
NORM-EXT GATED	NORM	Volts/Div	
PERIOD	.4 ms	Channel 1	50 mV
VARIABLE	1X	Channel 2	.5 V
PULSE DURATION	.2 ms		
VARIABLE	1X		
DELAY	20 ns		
VARIABLE	1X		
PULSE AMPLITUDE	5		
(+ and -)			
BASELINE OFFSET	OFF		
(+ and -)			
50 Ω INTERNAL TERMINATION	IN (connect 50 Ω termination to the unused OUTPUT)		

MODE	Alt
Triggering	Internal (Norm)
Coupling	LF Rej.

7. Check/Adjust Pulse Period and Pulse Duration ①

a. Equipment setup is shown in Fig. 5-8.

b. Apply the \square OUTPUT of the 2101 through a coaxial cable, a 50 Ω 10X attenuator, and a 50 Ω termination to channel 1 Input of a real time test oscilloscope. Apply the Marker Output from the time mark generator through a 50 Ω coaxial cable and 50 Ω termination to channel 2 of the test oscilloscope. Set the oscilloscope Mode selector to Alt position.

c. Apply .1 ms time markers to channel 2 and a 0.2 ms pulse with a period of .4 ms to channel 1 of the test oscilloscope. Adjust triggering level and vertical positioning controls so the two displays overlap (see Fig. 5-9). Adjust the 2101 PULSE AMPLITUDE control for a pulse amplitude of 6 divisions. Adjust the channel 2 vertical sensitivity (Volts/Div) for a marker amplitude of 2 divisions.

d. CHECK—The period and duration accuracy for each selection listed in Table 5-2. Check by observing the display after setting the test oscilloscope, time-marker output and 2101 selectors as follows:

Performance Check/Calibration—2101

1. Set the oscilloscope Time/Div and the 2101 PERIOD and DURATION selectors to the positions indicated in Table 5-2.

2. Apply the appropriate time-markers.

3. Switch the Horizontal Display to $\times 10$ Mag (Mag on).

4. Check the display for period and pulse duration tolerance by manually scanning the magnified display through a pulse period or pulse duration with the horizontal Position control. Tolerance is listed in Table 5-2.

5. Measure the pulse period between the same instantaneous amplitude points (usually the 50% point) of two consecutive pulses (see Fig. 5-9A).

6. Measure the pulse duration between the 50% amplitude points of the pulse leading and trailing edges (see Fig. 5-9B). Use a pulse amplitude of 6 divisions and position the top of the time-markers to the graticule center line. Adjust trigger level and HF stabilization for optimum marker and pulse coincidence.

Pulse period and duration accuracy must be within \pm (5% of the indicated position plus 3 ns).

e. ADJUST—The selected PERIOD and/or PULSE DURATION adjustments as listed in Table 5-3 and shown in Fig. 5-10 for optimum period and duration accuracy.

f. Recheck—Pulse duration and period accuracy as outlined in step d.

TABLE 5-2

PULSE PERIOD AND DURATION CHECKS

PERIOD/ DURATION	Time- markers	Time/Div Settings (Mag On)	Tolerance \leq (5% + 3 ns) (Major Divisions)
.4 ms/.2 ms	.1 ms	.1 ms	± 2 /period
	50 μ s	50 μ s	± 2 /pulse duration
40 ns/20 ns	5 ns	.05 μ s	± 1 /period
	5 ns	.05 μ s	± 0.8 /pulse duration
.4 μ s/.2 μ s	.1 μ s	.1 μ s	± 2.03 /period
	10 ns	.05 μ s	± 2.6 /pulse duration
4 μ s/2 μ s	1 μ s	1 μ s	± 2 /period
	.5 μ s	.5 μ s	± 2 /pulse duration
40 μ s/20 μ s	10 μ s	10 μ s	± 2 /period
	5 μ s	5 μ s	± 2 /pulse duration
4 ms/2 ms	1 ms	1 ms	± 2 /period
	.5 ms	.5 ms	± 2 /pulse duration
40 ms/20 ms	10 ms	10 ms	± 2 /period
	5 ms	5 ms	± 2 /pulse duration
¹ EXT TRIG/ .2 s	50 ms	50 ms	± 2 /pulse

¹Trigger the 2101 with 1.0 s trigger output from time-mark generator by connecting the Trigger Out (time-mark generator) to 2101 TRIG IN connector. Switch the oscilloscope Mode to Chop.

Note: All tolerance limits relate to magnified sweep. Check accuracy by moving the display within the graticule area, with the horizontal Position control, from one reference point to the next.

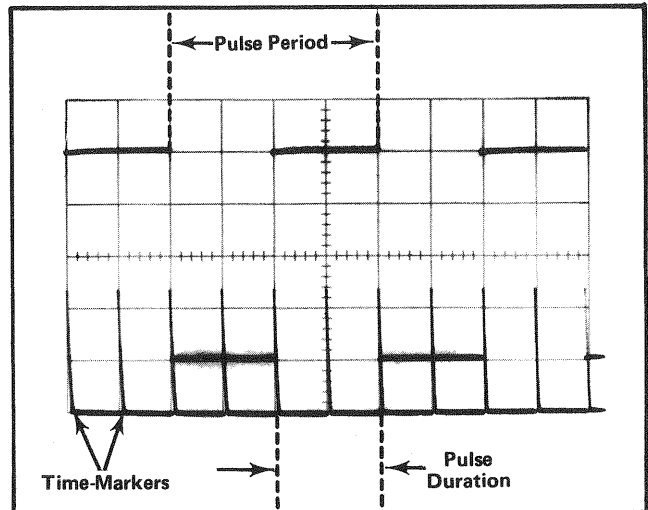

Fig. 5-9. Display showing 2101 pulse output and time markers, so pulse duration and period can be compared against time marker reference.

g. Set the PERIOD selector to .4 ms and the PULSE DURATION to 2 μ s. Set the test oscilloscope Time/Div to 10 μ s and turn the $\times 10$ Mag off. Apply 10 μ s time-markers to the test oscilloscope.

h. CHECK—The range of the PULSE DURATION VARIABLE control by rotating the control clockwise from a fully counterclockwise position and noting the increase in pulse duration. Must equal or exceed 20:1 or 40 μ s.

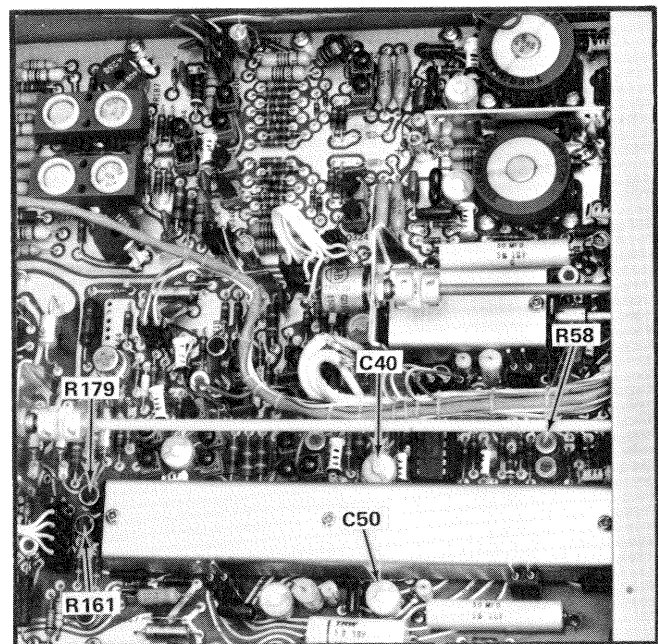

Fig. 5-10. Pulse period and pulse duration adjustments.

i. Return the PULSE DURATION VARIABLE control to the 1X position. Change the test oscilloscope Time/Div to 1 ms. Set the PERIOD to .4 ms and the PULSE DURATION to 20 μs. Apply 1 ms time markers.

j. CHECK—Range of the PERIOD VARIABLE by turning the control from CCW position fully clockwise and noting the increase in period. Must equal or exceed 10:1 or 4 ms.

TABLE 5-3

PULSE PERIOD AND DURATION ADJUSTMENTS

PERIOD/DURATION	Time-markers	Time/Div. Settings (Mag On)	Adjust
4 ms/2 ms	1 ms	1 ms	R58 (period)
	.5 ms	.5 ms	R179 (duration)
40 ns/20 ns	5 ns	.05 μs	Adjust C40 towards 40 ns period and R55 toward 20 ns duration. Alternately adjust the two until 40 ns period is obtained.
	5 ns	.05 μs	R161 for 20 ns duration. Recheck and adjust C40 and R55.
.4 ms/.2 ms	.1 ms	.1 ms	Adjust R58 (period) and R179 (duration) for best compromise between 4 ms/2 ms and .4 ms/.2 ms selections.
	50 μs	50 μs	
.4 μs/.2 μs	.1 μs	.1 μs	C50 (period)
	10 ns	.05 μs	C165 (duration)
4 μs/2 μs	1 μs	1 μs	Check period
	.5 μs	.5 μs	C161 (duration)

Recheck period and duration accuracy as outlined in Table 5-2. Repeat adjustments if necessary until selections are within specified tolerance. All checks and adjustments should be made with X10 magnified sweep.

8. Check/Adjust Delay Accuracy

a. Equipment setup is shown in Fig. 5-8 and given in step 7.

b. Reset the 2101 and test equipment controls as follows:

2101

PULSE MODE	PAIRED
PERIOD	EXT TRIG
VARIABLE	1X
PULSE DURATION	20 μs
VARIABLE	1X
DELAY	200 μs
VARIABLE	1X
50 Ω INTERNAL TERMINATION	IN
PULSE AMPLITUDE	5

Test Oscilloscope

Time/Div	50 μs
Mode	Chop
Triggering	Ext (Norm)

c. Apply the OUTPUT through a 50 Ω coaxial cable, a 10X attenuator, and a 50 Ω termination to one channel of the test oscilloscope. Apply 0.1 ms time-markers through a coaxial cable and a 50 Ω termination to the other channel of the test oscilloscope. Trigger the test oscilloscope externally by applying the 2101 PRETRIG OUT signal to the Ext Trigger Input of the test oscilloscope. Trigger the 2101 with the time-mark generator by applying the Trigger Out signal through a 50 Ω coaxial cable and a 50 Ω termination to the +TRIG IN connector.

d. Apply a 1 ms trigger signal and a .1 ms marker signal from the time-mark generator. Adjust the test oscilloscope triggering level, vertical sensitivity, and positioning controls for a dual display with a pulse amplitude of 4 divisions and a marker amplitude of approximately 2 divisions (see Fig. 5-11).

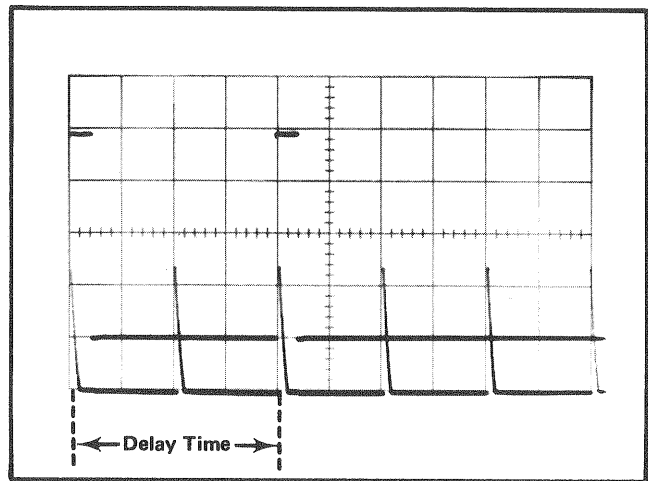

Fig. 5-11. Display of 2101 output pulse and time markers. Time markers are used to measure pulse delay.

e. CHECK—The delay accuracy for each DELAY selection listed in Table 5-4. Check by observing the display after setting the test oscilloscope, time-markers, and 2101 selectors as follows:

1. Set the oscilloscope Time/Div and the 2101 DELAY and PULSE DURATION selectors to the positions indicated in Table 5-4.
2. Apply the appropriate time markers and trigger signals.
3. Change the Horizontal Display to X10 Mag (Mag On).
4. Measure the delay time between the same instantaneous amplitude value (usually 50%) of leading edges of the undelayed and delayed pulses by manually scanning the magnified display through the delay period with the horizontal Position control. Tolerance is listed in Table 5-4. Delay time accuracy must be within ±(5% indicated selection plus 3 ns).

TABLE 5-4
PULSE DELAY CHECKS AND ADJUSTMENTS

Delay	PULSE DURATION	Time Mark Generator		Time/Div. Selection (Mag On)	Tolerance \leq (5% + 3 ns) (Major Div.)	Adjust
		Marker Out	Trigger			
200 μ s	20 μ s	50 μ s	1 ms	50 μ s	$\pm 2/200 \mu$ s	R101
2 ms	.2 ms	.5 ms	10 ms	.5 ms	$\pm 2/2$ ms	R118
20 ms	2 ms	5 ms	.1 s	5 ms	$\pm 2/20$ ms	Check
200 ms	20 ms	50 ms	1 s	50 ms	$\pm 2/200$ ms	
¹ 20 ns	20 ns	5 ns	.1 μ s	.05 μ s	$\pm 0.8/20$ ns	R105
² 200 ns	20 ns	50 ns	1 μ s	.05 μ s	$\pm 2.6/200$ ns	C102
² 2 μ s	.2 μ s	.5 μ s	10 μ s	.5 μ s	$\pm 2/2 \mu$ s	

¹To check or adjust 20 ns delay, switch the PULSE UNDLY'D and DELAYED positions noting the amount of delay. Measure the delay by setting the pulse amplitude to 6 divisions then position the marker to an amplitude reference point (usually 50% point).

²Return the 2101 PULSE MODE to PAIRED POSITION, and change the oscilloscope Mode to Alt, the trigger source to Internal, and trigger the display. This will eliminate the delay between the markers and the pulse output.

f. ADJUST—The delay adjustments, listed in Table 5-4, until the delay is within required tolerance. Fig. 5-12 shows the location of the delay calibration adjustments.

g. Set the PULSE MODE to DELAYED, the PULSE DURATION to 2 μ s and the DELAY to 2 μ s. Select 10 μ s time markers and 1 ms trigger output. Set the test oscilloscope Time/Div to 20 μ s and turn the $\times 10$ Mag off.

h. CHECK—The range of the DELAY VARIABLE control by rotating the control fully clockwise and noting the increased delay in the display. The range must equal or exceed 20:1 or 40 μ s.

9. Check Duty Factor

a. Equipment setup is shown in Fig. 5-8.

b. Apply the OUTPUT pulse, through a coaxial cable, a 10 \times attenuator and 50 Ω termination to the vertical input of the test oscilloscope. Trigger the test oscilloscope internally with the input signal.

c. Set the 2101 and test oscilloscope selector and controls as follows:

PERIOD	.4 ms
VARIABLE	1 \times
PULSE DURATION	.2 ms
VARIABLE	1 \times
DELAY	20 ns
NORM-EXT GATED	NORM
MODE	UNDLY'D
Time/Div	50 μ s

d. Increase the pulse duration for maximum duty factor by adjusting the PULSE DURATION VARIABLE until the pulse duration is just below that point where triggering becomes unstable.

e. CHECK—Duty factor by measuring the pulse duration and the period. Duty factor = pulse duration/pulse period ($\times 100\%$). Duty factor must equal or exceed 80% when period is 100 ns or more.

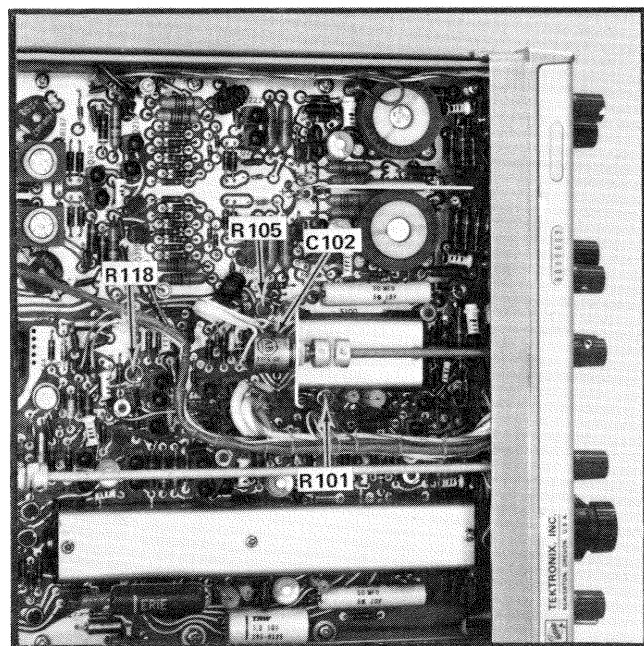

Fig. 5-12. Delay calibration adjustments.

10. Check Paired Separation

- a. Equipment setup is shown in Fig. 5-8.
- b. Apply the \square OUTPUT from the 2101 through a coaxial cable, a 10 \times attenuator and a 50 Ω termination to the vertical input of the test oscilloscope. Trigger the test oscilloscope externally from the + PRETRIG OUT signal.
- c. Set the 2101 and test oscilloscope controls as follows:

PERIOD	0.4 μ s
VARIABLE	1 \times
PULSE DURATION	20 ns
VARIABLE	1 \times
DELAY	20 ns
VARIABLE	1 \times
NORM-EXT GATED	NORM
MODE	PAIRED
PULSE AMPLITUDE	8
BASELINE OFFSET	OFF
50 Ω INTERNAL TERMINATION	IN
Time/Div	.2 μ s Magnified 10 \times (Equivalent 20 ns/Div)

- e. Adjust DELAY VARIABLE for minimum separation between the undelayed and delayed pulses.
- f. CHECK—Minimum paired pulse separation must equal 20 ns or 20% of pulse duration, whichever is greater.

MODES OF OPERATION; TRIGGERS AND TRIGGERING

11. Check Pulse Modes of Operation

- a. Test equipment setup is shown in Fig. 5-8.
- b. Apply the \square OUTPUT signal from the 2101 through a coaxial cable, a 10 \times attenuator, and a 50 Ω termination to one channel of the vertical input for the test oscilloscope. Apply the + PRETRIG OUT signal from the 2101 to the External Trigger Input of the test oscilloscope.
- c. Set the 2101 and test oscilloscope controls and selectors as follows:

2101

PERIOD	.4 ms
VARIABLE	1 \times
PULSE DURATION	.2 ms
VARIABLE	1 \times
DELAY	200 μ s
VARIABLE	1 \times
NORM-EXT GATE	NORM
MODE	UNDLY'D

Test Oscilloscope

Time/Div	50 μ s
----------	------------

- d. Adjust the test oscilloscope triggering level controls for a triggered display.
- e. CHECK—The test oscilloscope display for an undelayed, .2 ms output pulse with a period of .4 ms.
- f. Switch the PULSE DURATION to 2 μ s and the PULSE MODE to the DELAYED position. Pulse should now be delayed 200 μ s.
- g. Change the DELAY selector to 20 μ s and rotate the DELAY VARIABLE control.
- h. CHECK—The delay time of the pulse should increase as the VARIABLE control is rotated clockwise. Return the VARIABLE control to the 1 \times position and the DELAY selector to 200 μ s.
- i. Switch the PULSE MODE selector to PAIRED position.
- j. CHECK—The display should now contain pulse pairs. The second pulse of each pair must be delayed from the undelayed according to the settings of the delay control, provided the pulse duration plus delay time equals or is less than the pulse period.
- k. Switch the PULSE MODE selector to OUTPUT LATCHED ON position.
- l. CHECK—The display should now show a DC output level that equals the PULSE AMPLITUDE and BASELINE OFFSET control settings.

NOTES

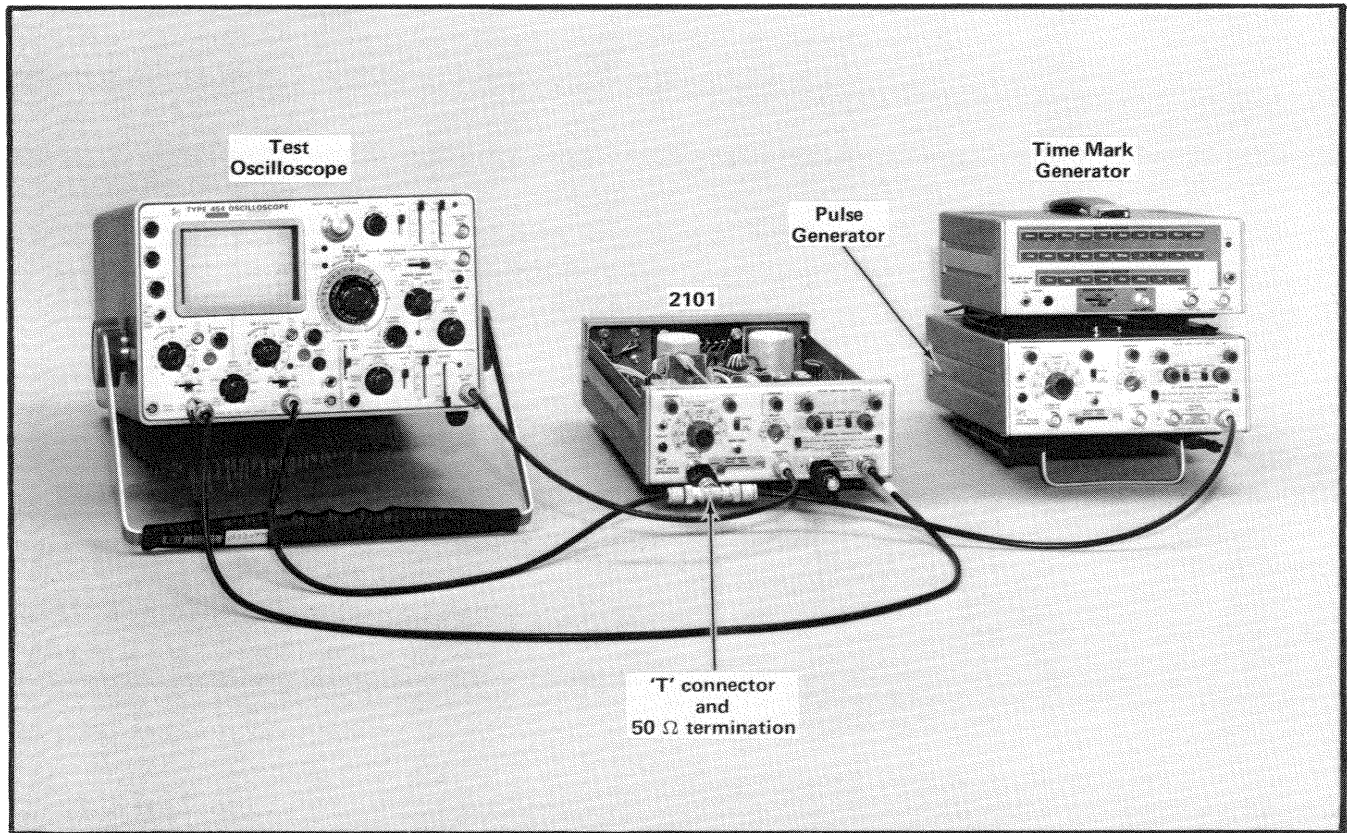

Fig. 5-13. Test equipment setup to check external gated mode and external trigger operation. (Step 12)

Control settings for Fig. 5-13

	2101
PULSE MODE	UNDLY'D
PULSE DURATION	20 μ s
VARIABLE	1 \times
PERIOD	40 μ s
VARIABLE	1 \times
NORM EXT GATED	EXT GATED
PULSE AMPLITUDE	5 V
BASELINE OFFSET	OFF
50 Ω INTERNAL	IN
TERMINATION	

(Aux) Pulse Generator

Pulse Duration	Approximately 50 μ s
Period	Approximately 100 μ s
Pulse Amplitude	2 V into 50 Ω
Baseline Offset	Out

Test Oscilloscope

Time/Div	20 μ s
Volts/Div (Both Channels)	.5
Mode	Alternate

12. Check Gated Mode Operation (Input Amplitude, Reset Level, Frequency)

a. Equipment setup is shown in Fig. 5-13.

b. Apply the positive-going output pulse from a pulse generator (e.g. 2101 Pulse Generator) through a coaxial cable, a 50 Ω termination and a BNC 'T' connector to the + GATE IN connector. Connect one channel of the test oscilloscope to the BNC 'T' connector so the input pulse amplitude to the GATE IN can be monitored. Apply the \square OUTPUT of the 2101 through a coaxial cable and a 10 \times attenuator to the other channel of the test oscilloscope. Trigger the test oscilloscope externally from the + PRETRIG OUT.

c. Adjust the amplitude of the input gate pulse to the + GATE INPUT connector from 1 V to 3 V maximum.

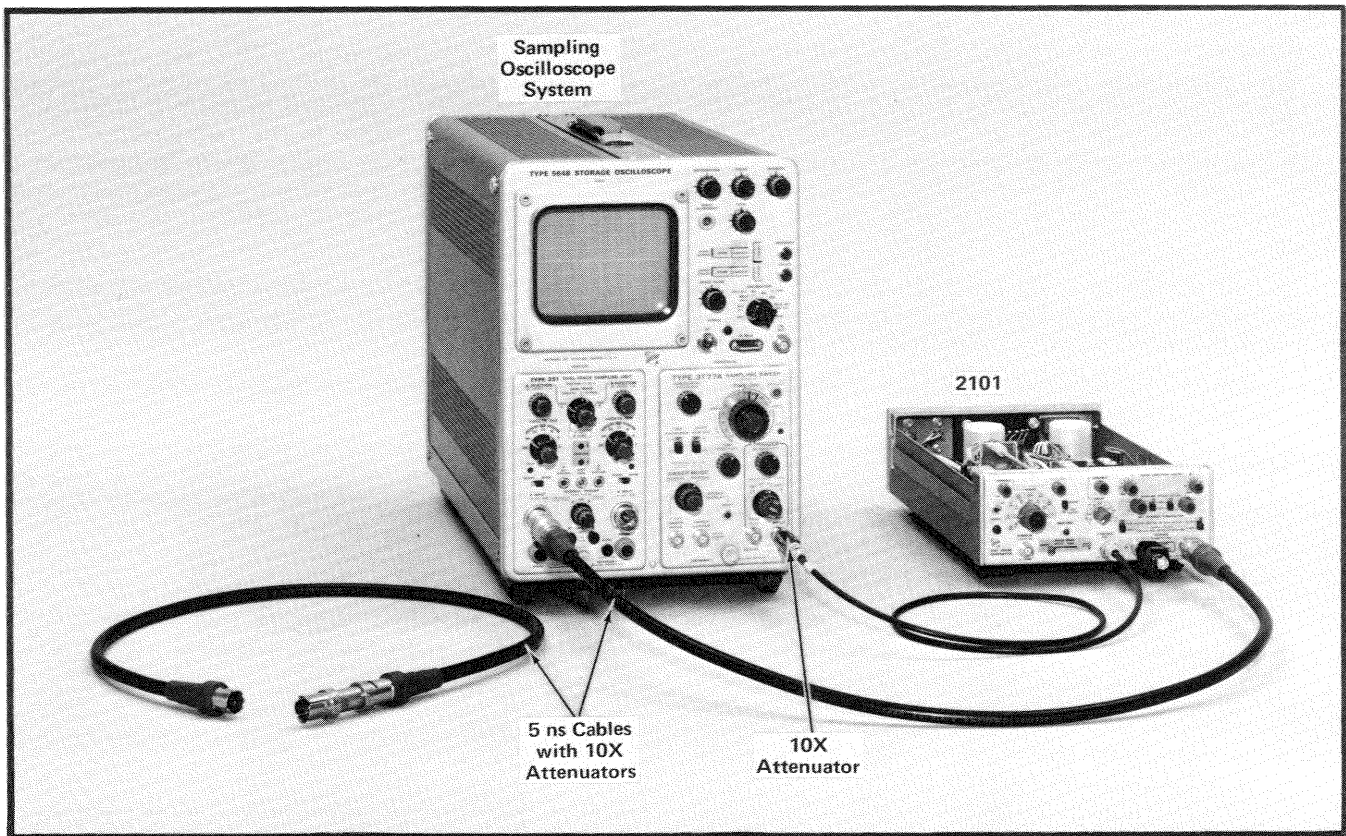

Fig. 5-14. Test equipment setup to check/adjust pulse shape, output pulse coincidence, range of AMPLITUDE and OFFSET controls and PRE-TRIGGER lead time. (Steps 14 through 19)

Control settings for Fig. 5-14

	2101
PULSE MODE	UNDLY'D
PULSE DURATION	.2 μ s
VARIABLE	1X
PERIOD	.4 μ s
VARIABLE	1X
NORM-EXT GATED	NORM
PULSE AMPLITUDE	
(- and +)	5
BASELINE OFFSET	OFF
50 Ω INTERNAL	
TERMINATION	OUT

Test Oscilloscope

Time/Div	20 ns
Volts/Div	100 mV
Mode	Channel 1

14. Check/Adjust Pulse Shape (Preshoot, Overshoot and Ringing, Rounding, and Flatness). ①

a. Equipment setup is shown in Fig. 5-14.

b. Apply the \square OUTPUT pulse through a 5 ns, 50 Ω coaxial cable and a 10X attenuator to the vertical input of a sampling unit. Apply the + PRETRIG OUT through a coaxial cable and a 10X attenuator to the Ext Trigger Input of the sampling time-base unit. Adjust the triggering controls for a triggered display.

c. Adjust the 2101 PULSE AMPLITUDE control for a pulse amplitude of 5 divisions on the test oscilloscope.

d. Switch the mVolts/Div selector, on the sampling unit, to 10 mV/Div. Position the display with the sampling unit DC Offset control, so the pulse baseline then the pulse top can be observed.

e. CHECK—The pulse shape for the degree of preshoot, overshoot and ringing, rounding, and the flatness of the pulse top and baseline see Fig. 5-15. Pulse aberrations must not exceed 3% of the pulse amplitude (1.5 div.) or 100 mV whichever is greater.

Pulse top flatness is measured within a time interval 5 ns after the 90% amplitude point to 5 ns prior to the trailing edge 90% amplitude point. Baseline flatness is measured within the time interval 5 ns after the 10% amplitude point of the trailing edge to 5 ns prior to the 10% amplitude point of the leading edge of the succeeding pulse. Slope of the top or baseline must not exceed 3% of the pulse amplitude. Slope must not exceed 1.5 major divisions with a pulse amplitude of 50 divisions.

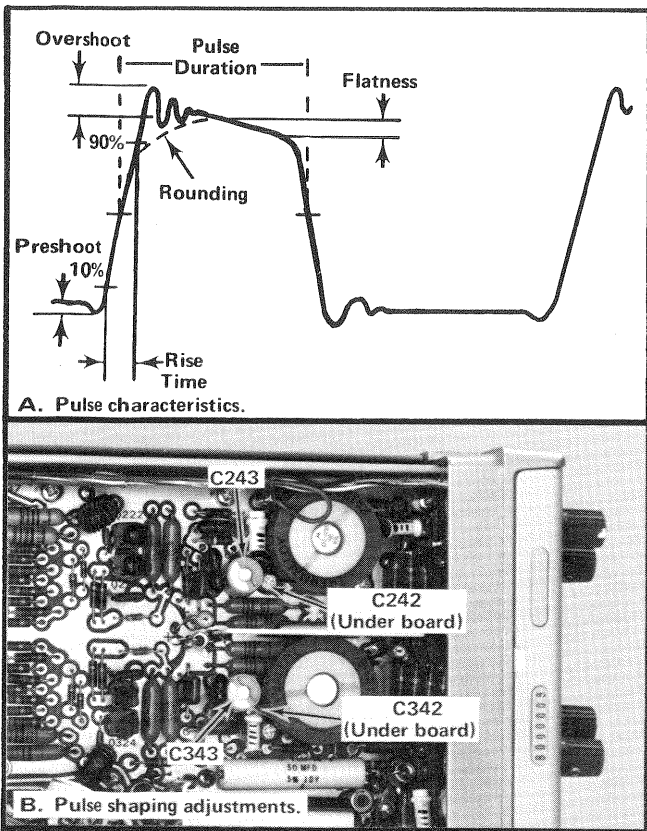

Fig. 5-15. Pulse shape characteristics and adjustments.

f. ADJUST—C243 and C242 (Fig. 5-15) for optimum pulse shape. C243 adjusts the front corner of the positive-going pulse and C242 adjusts the region 5 ns after the front corner.

g. Remove the \square OUTPUT pulse from the input to the sampling unit and apply the \square OUTPUT through a 5 ns, 50 Ω coaxial cable and a 10 \times attenuator to the input of the sampling unit. (If the sampling unit is a dual trace unit with both OUTPUTS connected as shown in the setup figure, switch the input selector to the negative-going pulse input channel.) Switch the mVolts/Div to 100 mV/Div and adjust the PULSE AMPLITUDE control for a 5-division signal amplitude.

h. CHECK—Pulse shape characteristics of the negative-going pulse as described in steps d and e for the positive-going pulse.

i. ADJUST—C343 and C344 (Fig. 5-15) for optimum pulse shape. C344 adjusts the front corner of the negative-going pulse and C342 affects the first 5 ns after the front corner.

Preshoot time interval is 5 ns prior to the 10% amplitude point of the leading edge and 5 ns prior to the 90% amplitude point of the trailing edge. Preshoot must not exceed 3% of the pulse amplitude or 30 mV, whichever is greater. It must not exceed 1.5 major divisions with a pulse amplitude of 50 divisions.

Overshoot and ringing and pulse rounding time interval is 5 ns after the 90% amplitude on the leading edge and 5 ns after the 10% amplitude point on the trailing edge. They must not exceed 3% of pulse amplitude or 100 mV, which-

ever is greater. Overshoot must not exceed 1.5 major divisions with a pulse amplitude of 50 divisions.

15. Check Pulse Risetime and Faltime

a. Equipment setup is given in step 14 and shown in Fig. 5-14.

b. Apply the \square OUTPUT pulse through a 5 ns, 50 Ω cable and a 10 \times attenuator to the sampling unit vertical input as described in step 14. Set the mVolt/Div selector to 100 mV. Adjust the 2101 PULSE AMPLITUDE control for a pulse amplitude of 5 divisions.

c. CHECK—The risetime and falltime of the OUTPUT pulses as follows:

1) Switch the sampling unit mode to the applicable channel, if a dual channel (Type 3S1) sampling unit is used.

2) Position the leading edge of the pulse, with the sweep delay control or the horizontal centering control, so the 10% amplitude point (0.5 div. above the baseline) intercepts a vertical graticule line.

3) Note the time difference to the 90% amplitude point, or position the 90% amplitude point to the reference vertical graticule line.

4) Repeat the procedure with the pulse trailing edge to measure fall time.

5) Switch the sampling unit mode to the other channel and repeat the procedure to check rise and falltime of the other pulse OUTPUT. Rise and falltime must not exceed 5 ns.

16. Check Output Pulse Coincidence

a. Equipment setup is given in step 14.

b. Apply the two OUTPUTS from the 2101 to the vertical inputs of a dual channel sampling unit as described in step 14. Apply the + PRETRIG OUT signal to the test oscilloscope Ext Trig input.

c. Invert the negative-going pulse input so both displays can be superimposed. Adjust the PULSE AMPLITUDE of both OUTPUTS so the two pulses have equal amplitude. Superimpose both displays.

d. CHECK—The leading edge coincidence of the two pulses at the 50% amplitude point. Coincidence must be within 2 ns.

NOTE

Cable and sampling amplifier delays must be the same for both channels.

17. Check Range of the Pulse Amplitude Controls

a. Equipment setup is shown in Fig. 5-14 and given in step 16.

b. Apply both OUTPUTS from the 2101 through coaxial cables and 10 \times attenuators to the vertical inputs of the sampling unit. Adjust the triggering and position controls for a dual display on the CRT.

c. Set the Volts/Div selectors to 200 and the Variable controls to Cal. Rotate the 2101 PULSE AMPLITUDE controls fully clockwise to 10.

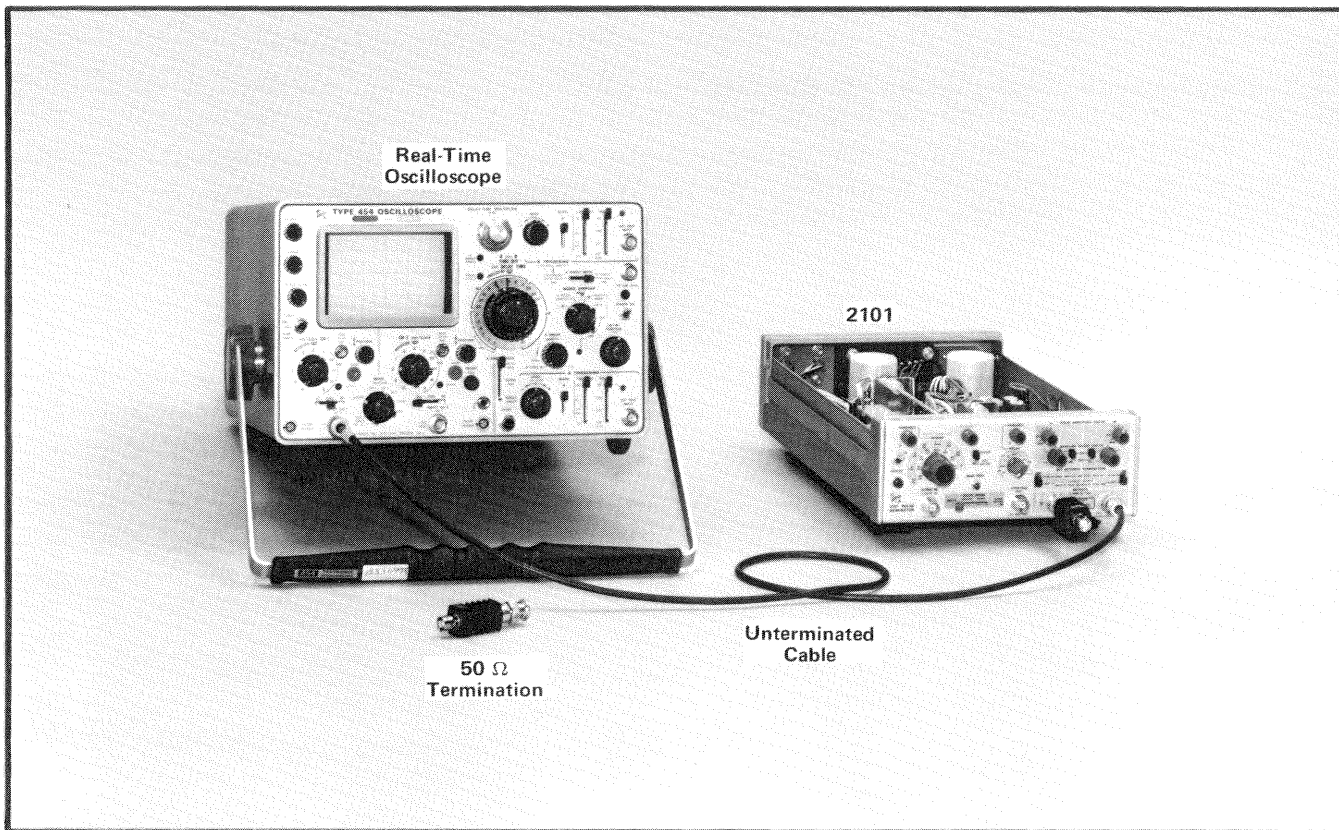

Fig. 5-16. Equipment setup to check internal source resistance, and output limiting. (Steps 20 and 21)

Control Settings for Fig. 5-16.

2101

PULSE MODE	UNDLY'D
PULSE DURATION	2 ms
PERIOD	EXT TRIG
NORM- EXT GATED	NORM
PULSE AMPLITUDE	Counterclockwise
BASELINE OFFSET	ON
50 Ω INTERNAL TERMINATION	OUT

Test Oscilloscope

Time/Div	1 ms
Volts/Div	10
Input Coupling	DC
Triggering	Auto

20. Check Internal Source Resistance

a. Equipment setup is shown in Fig. 5-16.

b. With the PERIOD selector at EXT TRIG, apply the \square OUTPUT from the 2101, through an unterminated coaxial cable to the high impedance input of a real time test oscilloscope. Set the 2101 and test oscilloscope controls and selectors as listed for Fig. 5-16.

c. With the 50 Ω INTERNAL TERMINATION switched OUT, adjust the BASELINE OFFSET control for a reference DC voltage level on the test oscilloscope. (10 V or 1 division is a good voltage amplitude reference. Switch the Input Coupling to Gnd position momentarily to establish zero volt reference.)

d. Disconnect the coaxial cable from the vertical input, add a 50 Ω termination and reconnect the terminated cable to the vertical input.

e. Increase the vertical sensitivity to 1 V/Div. Switch the input Coupling to Gnd and re-establish zero voltage reference.

f. Switch the Input Coupling to DC. Note the OUTPUT DC level.

g. CHECK—The source resistance with the OUTPUT unterminated. The source resistance is computed by the following formula:

$$R_{\text{source}} = 50 \left(\frac{E_{\text{open}} - 1}{E_{\text{load}}} \right)$$

Source resistance must equal or exceed 1500 Ω.

Performance Check/Calibration—2101

h. Switch the 50 Ω INTERNAL TERMINATION to IN position.

i. CHECK—The source resistance with the 50 Ω INTERNAL TERMINATION IN, by repeating the procedure described. Source resistance must equal 50 $\Omega \pm 2.5 \Omega$.

j. CHECK—The source resistance of the \square OUTPUT with the 50 Ω INTERNAL TERMINATION first OUT and then IN using the above procedure.

21. Check Amplitude Limit of Output Pulses.

a. Equipment setup is shown in Fig. 5-16.

b. Reset the 2101 and test oscilloscope controls as follows:

PULSE DURATION	.2 ms
PERIOD	.4 ms
PULSE AMPLITUDE	10
BASELINE OFFSET	ON

50 Ω INTERNAL TERMINATION	OUT
Time/Div	1 ms

c. Apply the \square OUTPUT from the 2101 through an un-terminated coaxial cable to the vertical input of a real time oscilloscope.

d. Rotate the BASELINE control fully counterclockwise to the -2 position.

e. CHECK—Pulse should limit between +21 and -21 Volts.

f. Remove the \square OUTPUT pulse and apply the \square OUTPUT to the test oscilloscope.

g. CHECK—The voltage limits for the \square OUTPUT. (PULSE AMPLITUDE fully clockwise and BASELINE OFFSET fully clockwise to +2 position). OUTPUT should limit between -21 and +7 Volts.

PARTS LIST ABBREVIATIONS

BHB	binding head brass	int	internal
BHS	binding head steel	lg	length or long
cap.	capacitor	met.	metal
cer	ceramic	mtg hdw	mounting hardware
comp	composition	OD	outside diameter
conn	connector	OHB	oval head brass
CRT	cathode-ray tube	OHS	oval head steel
csk	countersunk	PHB	pan head brass
DE	double end	PHS	pan head steel
dia	diameter	plstc	plastic
div	division	PMC	paper, metal cased
elect.	electrolytic	poly	polystyrene
EMC	electrolytic, metal cased	prec	precision
EMT	electrolytic, metal tubular	PT	paper, tubular
ext	external	PTM	paper or plastic, tubular, molded
F & I	focus and intensity	RHB	round head brass
FHB	flat head brass	RHS	round head steel
FHS	flat head steel	SE	single end
Fil HB	fillister head brass	SN or S/N	serial number
Fil HS	fillister head steel	SW	switch
h	height or high	TC	temperature compensated
hex.	hexagonal	THB	truss head brass
HHB	hex head brass	thk	thick
HHS	hex head steel	THS	truss head steel
HSB	hex socket brass	tub.	tubular
HSS	hex socket steel	var	variable
ID	inside diameter	w	wide or width
incd	incandescent	WW	wire-wound



PARTS ORDERING INFORMATION

Replacement parts are available from or through your local Tektronix, Inc. Field Office or representative.

Changes to Tektronix instruments are sometimes made to accommodate improved components as they become available, and to give you the benefit of the latest circuit improvements developed in our engineering department. It is therefore important, when ordering parts, to include the following information in your order: Part number, instrument type or number, serial or model number, and modification number if applicable.

If a part you have ordered has been replaced with a new or improved part, your local Tektronix, Inc. Field Office or representative will contact you concerning any change in part number.

SPECIAL NOTES AND SYMBOLS

- ×000 Part first added at this serial number
- 00× Part removed after this serial number
- *000-0000-00 Asterisk preceding Tektronix Part Number indicates manufactured by or for Tektronix, Inc., or reworked or checked components.
- Use 000-0000-00 Part number indicated is direct replacement.
-  Screwdriver adjustment.
-  Control, adjustment or connector.

INDEX OF ELECTRICAL PARTS LIST

Title	Page No.
CHASSIS	6-1
GENERATOR Circuit Board Assembly	6-2



SECTION 6

ELECTRICAL PARTS LIST

Values are fixed unless marked Variable.

Ckt. No.	Tektronix Part No.	Serial/Model No. Eff	No. Disc	Description		
CHASSIS						
Bulb						
DS401	150-0045-00			Incandescent #685		
Capacitors						
Tolerance $\pm 20\%$ unless otherwise indicated.						
C66	283-0005-00		0.01 μF	Cer	250 V	
C240	283-0178-00		0.1 μF	Cer	100 V	+100% -20%
C340	283-0178-00		0.1 μF	Cer	100 V	+80% -20%
C410	290-0444-00		2000 μF	Elect.	50 V	+100% -10%
C430	290-0444-00		2000 μF	Elect.	50 V	+100% -10%
Fuses						
F401	159-0043-00		0.6 A	3AG	Slo-Blo	
F403	159-0031-00		0.4 A	3AG	Slo-Blo	
Connectors						
J1	131-0955-00			Receptacle, electrical, BNC		
J72	131-0955-00			Receptacle, electrical, BNC		
J280	131-0955-00			Receptacle, electrical, BNC		
J380	131-0955-00			Receptacle, electrical, BNC		
Inductors						
L66	*108-0215-00		1.1 μH			
Transistors						
Q420	151-0226-00		Silicon	NPN	TO-66	2N3767
Q440	151-0226-00		Silicon	NPN	TO-66	2N3767

CHASSIS (cont)

Ckt. No.	Tektronix Part No.	Serial/Model No. Eff	Disc	Description
----------	--------------------	----------------------	------	-------------

Resistors

Resistors are fixed, composition, $\pm 10\%$ unless otherwise indicated.

R50	311-0546-00		10 k Ω , Var			
R66	321-0094-00		93.1 Ω	1/8 W	Prec	1%
R240	311-1032-00		2 k Ω , Var			
R255	311-0642-00		20 k Ω , Var			
R288	305-0101-00		100 Ω	2 W		5%
R289	305-0101-00		100 Ω	2 W		5%
R340	311-1032-00		2 k Ω , Var			
R355	311-0642-00		20 k Ω , Var			
R388	305-0101-00		100 Ω	2 W		5%
R389	305-0101-00		100 Ω	2 W		5%

Switches

Wired or Unwired

S1	260-0247-00		Pushbutton	MAN TRIG
S20	260-0816-00		Slide	MODE
S120	260-1120-00		Lever	PULSE MODE
S255	260-0816-00		Slide	ON-OFF
S280	260-0816-00		Slide	50 Ω INTERNAL TERMINATION
S355	260-0816-00		Slide	ON-OFF
S380	260-0816-00		Slide	50 Ω INTERNAL TERMINATION
S401	260-0834-00		Toggle	POWER
S402	260-0227-00		Thermo Cutout 165°	
S403 ¹				
S404 ¹				

Transformer

T401	*120-0657-00		Power
------	--------------	--	-------

GENERATOR Circuit Board Assembly

*670-1167-00

Complete Board

Capacitors

Tolerance $\pm 20\%$ unless otherwise indicated.

C3	281-0525-00	470 pF	Cer	500 V	
C11	283-0178-00	0.1 μ F	Cer	100 V	+80%—20%
C13	281-0656-00	22 pF	Cer	200 V	5%
C31	283-0178-00	0.1 μ F	Cer	100 V	+80%—20%
C40	281-0092-00	9-35 pF, Var	Cer		

¹See Mechanical Parts List. Line Voltage Selector Body.

GENERATOR Circuit Board Assembly (cont)

Ckt. No.	Tektronix Part No.	Serial/Model No. Eff Disc	Description			
Capacitors (cont)						
C41	281-0656-00		22 pF	Cer	200 V	5%
C42	*295-0132-00		50 μ F	Matched set		
C43			5 μ F			
C45			0.5 pF			
C47			0.05 μ F			
C48			0.005 μ F			
C49						
C50	281-0092-00		9-35 pF, Var	Cer		
C51	283-0604-00		304 pF	Mica	300 V	2%
C61	283-0178-00		0.1 μ F	Cer	100 V	+80%—20%
C63	281-0656-00		22 pF	Cer	200 V	5%
C67	281-0600-00		35 pF	Cer		10%
C73	283-0005-00		0.01 μ F	Cer	250 V	
C87	281-0504-00		10 pF	Cer	500 V	10%
C89	283-0178-00		0.1 μ F	Cer	100 V	+80%—20%
C95	283-0178-00		0.1 μ F	Cer	100 V	+80%—20%
C101	281-0656-00		22 pF	Cer	200 V	5%
C102	281-0092-00		9-35 pF, Var	Cer		
C105	*295-0133-00		50 μ F	Matched set		
C107			0.5 μ F			
C109			0.005 μ F			
C120		283-0178-00				
C121	283-0178-00		0.1 μ F	Cer	100 V	+80%—20%
C124	283-0178-00		0.1 μ F	Cer	100 V	+80%—20%
C141	281-0549-00		68 pF	Cer	500 V	10%
C153	281-0504-00		10 pF	Cer	500 V	10%
C156	281-0572-00		6.8 pF	Cer	500 V	\pm 0.5 pF
C157	283-0178-00		0.1 μ F	Cer	100 V	+80%—20%
C161	281-0092-00		9-35 pF, Var	Cer		
C163	283-0628-00		410 pF	Mica	500 V	1%
C165	281-0092-00		9-35 pF, Var	Cer		
C166	281-0656-00		22 pF	Cer	200 V	5%
C181	283-0178-00		0.1 μ F	Cer	100 V	+80%—20%
C182	283-0178-00		0.1 μ F	Cer	100 V	+80%—20%
C187	281-0518-00		47 pF	Cer	500 V	
C195	283-0178-00		0.1 μ F	Cer	100 V	+80%—20%
C201	283-0178-00		0.1 μ F	Cer	100 V	+80%—20%
C211	283-0178-00		0.1 μ F	Cer	100 V	+80%—20%
C235	283-0178-00		0.1 μ F	Cer	100 V	+80%—20%
C241	283-0632-00		87 pF	Mica	100 V	1%
C242	281-0092-00		9-35 pF, Var	Cer		
C243	281-0092-00		9-35 pF, Var	Cer		

GENERATOR Circuit Board Assembly (cont)

Ckt. No.	Tektronix Part No.	Serial/Model No. Eff	Disc	Description		
Capacitors (cont)						
C244	281-0600-00		35 pF	Cer		10%
C245	283-0633-00		77 pF	Mica	100 V	1%
C246	290-0415-00		5.6 μ F	Elect.	35 V	10%
C248	283-0177-00		1 μ F	Cer	25 V	+80%—20%
C249	290-0135-00		15 μ F	Elect.	20 V	
C287	281-0504-00		10 pF	Cer	500 V	10%
C301	283-0178-00		0.1 μ F	Cer	100 V	+80%—20%
C305	283-0178-00		0.1 μ F	Cer	100 V	+80%—20%
C311	283-0178-00		0.1 μ F	Cer	100 V	+80%—20%
C335	283-0178-00		0.1 μ F	Cer	100 V	+80%—20%
C341	283-0632-00		87 pF	Mica	100 V	1%
C342	281-0092-00		9-35 pF, Var	Cer		
C343	281-0092-00		9-35 pF, Var	Cer		
C344	281-0513-00		27 pF	Cer	500 V	
C345	283-0633-00		77 pF	Mica	100 V	1%
C346	290-0136-00		2.2 μ F	Elect.	20 V	
C348	283-0177-00		1 μ F	Cer	25 V	+80%—20%
C349	290-0135-00		15 μ F	Elect.	20 V	
C375	283-0160-00		1.5 pF	Cer	50 V	10%
C387	281-0504-00		10 pF	Cer	500 V	10%
C415	281-0523-00		100 pF	Cer	350 V	
C423	290-0135-00		15 μ F	Elect.	20 V	
C435	281-0523-00		100 pF	Cer	350 V	
C442	290-0135-00		15 μ F	Elect.	20 V	
C443	290-0135-00		15 μ F	Elect.	20 V	
C444	283-0177-00		1 μ F	Cer	25 V	+80%—20%
C445	290-0135-00		15 μ F	Elect.	20 V	
C446	283-0177-00		1 μ F	Cer	25 V	+80%—20%
C447	290-0135-00		15 μ F	Elect.	20 V	
C448	283-0177-00		1 μ F	Cer	25 V	+80%—20%

Semiconductor Device, Diodes

CR1	152-0141-02	Silicon	1N4152
CR2	*152-0322-00	Silicon	Tek Spec
CR3	152-0141-02	Silicon	1N4152
CR10	152-0141-02	Silicon	1N4152
CR21	152-0141-02	Silicon	1N4152
CR23	152-0071-00	Germanium	ED2007
VR61	152-0166-00	Zener	1N753A 400 mW, 6.2 V, 5%
CR62	152-0141-02	Silicon	1N4152
CR63	*152-0322-00	Silicon	Tek Spec
CR85	152-0079-00	Germanium	HD1841

GENERATOR Circuit Board Assembly (cont)

Ckt. No.	Tektronix Part No.	Serial/Model No. Eff	Disc	Description
Semiconductor Device, Diodes (cont)				
CR86	152-0141-02		Silicon	1N4152
CR121	152-0141-02		Silicon	1N4152
CR124	*152-0322-00		Silicon	Tek Spec
CR135	152-0141-02		Silicon	1N4152
CR136	152-0079-00		Germanium	HD1841
CR151	152-0079-00		Germanium	HD1841
CR152	152-0141-02		Silicon	1N4152
CR181	152-0141-02		Silicon	1N4152
CR182	*152-0322-00		Silicon	Tek Spec
CR187	152-0141-02		Silicon	1N4152
VR187	152-0226-00		Zener	1N751A 400 mW, 5.1 V, 5%
CR235	*152-0322-00		Silicon	Tek Spec
CR237	152-0309-00		Zener	1N3828A 1 W, 6.2 V, 5%
CR238	152-0141-02		Silicon	1N4152
CR256	152-0025-00		Germanium	1N634
CR257	152-0025-00		Germanium	1N634
CR335	*152-0322-00		Silicon	Tek Spec
VR337	152-0309-00		Zener	1N3828A 1 W, 6.2 V, 5%
CR338	152-0141-02		Silicon	1N4152
CR356	152-0025-00		Germanium	1N634
CR357	152-0025-00		Germanium	1N634
CR410	152-0199-00		Rectifier bridge	MDA 962-3
VR412	152-0294-00		Zener	1N3033B 1 W, 36 V, 5%
VR427	152-0279-00		Zener	1N751A 400 mW, 5.1 V, 5%
VR429	152-0309-00		Zener	1N3828A 1 W, 6.2 V, 5%
CR430	152-0199-00		Rectifier bridge	MDA 962-3
VR432	152-0294-00		Zener	1N3033B 1 W, 36 V, 5%
CR443	152-0141-02		Silicon	1N4152
CR444	152-0141-02		Silicon	1N4152
VR444	152-0306-00		Zener	1N960B 400 mW, 9.1 V, 5%
VR445	152-0226-00		Zener	1N751A 400 mW, 5.1 V, 5%
VR447	152-0226-00		Zener	1N751A 400 mW, 5.1 V, 5%

Inductors

L50	*120-0402-00		Toroid, 3 turns, single
L136	*108-0367-00		1 μ H
L182	276-0507-00		Core, ferramic suppressor
L187	276-0507-00		Core, ferramic suppressor
L273	*108-0596-00		5.4 μ H

GENERATOR Circuit Board Assembly (cont)

Ckt. No.	Tektronix Part No.	Serial/Model No. Eff	Disc	Description
Inductors (cont)				
L274	*108-0597-00		425 μ H	
L275	*108-0147-00		2.2 μ H	
L373	*108-0596-00		5.4 μ H	
L374	*108-0597-00		425 μ H	
LR229	*108-0270-00		0.25 μ H (wound on a 62 Ω resistor)	
LR329	*108-0270-00		0.25 μ H (wound on a 62 Ω resistor)	
LR375	*108-0114-00		6 μ H (wound on a 220 Ω resistor)	
Transistors				
Q62	151-0220-00		Silicon	PNP TO-18 2N4122
Q66	151-0221-00		Silicon	PNP TO-18 2N4258
Q72	151-0220-00		Silicon	PNP TO-18 2N4122
Q82	151-0225-00		Silicon	NPN TO-18 2N3563
Q84	151-0221-00		Silicon	PNP TO-18 2N4258
Q90	151-0223-00		Silicon	NPN TO-18 2N4275
Q94	151-0225-00		Silicon	NPN TO-18 2N3563
Q96	151-0225-00		Silicon	NPN TO-18 2N3563
Q124	151-0223-00		Silicon	NPN TO-18 2N4275
Q130	151-0221-00		Silicon	PNP TO-18 2N4258
Q142	151-0221-00		Silicon	PNP TO-18 2N4258
Q144	151-0225-00		Silicon	NPN TO-18 2N3563
Q146	151-0225-00		Silicon	NPN TO-18 2N3563
Q150	*151-0271-00		Silicon	PNP TO-18 Tek Spec
Q154	151-0223-00		Silicon	NPN TO-18 2N4275
Q156	151-0225-00		Silicon	NPN TO-18 2N3563
Q158	151-0225-00		Silicon	NPN TO-18 2N3563
Q182	151-0225-00		Silicon	NPN TO-18 2N3563
Q184	151-0221-00		Silicon	PNP TO-18 2N4258
Q194	151-0223-00		Silicon	NPN TO-18 2N4275
Q196	151-0223-00		Silicon	NPN TO-18 2N4275
Q210	*151-0269-00		Silicon	NPN TO-106 Selected from SE 3005
Q212	*151-0269-00		Silicon	NPN TO-106 Selected from SE 3005
Q222	*151-0269-00		Silicon	NPN TO-106 Selected from SE 3005
Q224	*151-0269-00		Silicon	NPN TO-106 Selected from SE 3005
Q252	*151-0285-00		Silicon	PNP TO-39 Tek Spec
Q254	*151-0285-00		Silicon	PNP TO-39 Tek Spec
Q268	151-0208-00		Silicon	PNP TO-5 2N4036
Q270	*151-0136-00		Silicon	NPN TO-5 Replaceable by 2N3053

GENERATOR Circuit Board Assembly (cont)

Ckt. No.	Tektronix Part No.	Serial/Model No. Eff	Disc	Description
Transistors (cont)				
Q310	*151-0271-00		Silicon	PNP TO-18 Tek Spec
Q312	*151-0271-00		Silicon	PNP TO-18 Tek Spec
Q322	*151-0271-00		Silicon	PNP TO-18 Tek Spec
Q324	*151-0271-00		Silicon	PNP TO-18 Tek Spec
Q352	151-0288-00		Silicon	NPN TO-39 A210
Q354	151-0288-00		Silicon	NPN TO-39 A210
Q368	151-0208-00		Silicon	PNP TO-5 2N4036
Q370	*151-0136-00		Silicon	NPN TO-5 Replaceable by 2N3053
Q412	*151-0136-00		Silicon	NPN TO-5 Replaceable by 2N3053
Q432	*151-0136-00		Silicon	NPN TO-5 Replaceable by 2N3053
Q444	*151-0134-00		Silicon	PNP TO-5 Replaceable by 2N2905

Resistors

Resistors are fixed, composition, $\pm 10\%$ unless otherwise indicated.

R1	315-0101-00	100 Ω	$\frac{1}{4}$ W	5%
R2	315-0101-00	100 Ω	$\frac{1}{4}$ W	5%
R3	316-0336-00	33 M Ω	$\frac{1}{4}$ W	
R9	315-0751-00	750 Ω	$\frac{1}{4}$ W	5%
R10	315-0101-00	100 Ω	$\frac{1}{4}$ W	5%
R11	315-0102-00	1 k Ω	$\frac{1}{4}$ W	5%
R13	315-0471-00	470 Ω	$\frac{1}{4}$ W	5%
R15	315-0222-00	2.2 k Ω	$\frac{1}{4}$ W	5%
R19	315-0152-00	1.5 k Ω	$\frac{1}{4}$ W	5%
R23	315-0102-00	1 k Ω	$\frac{1}{4}$ W	5%
R31	315-0222-00	2.2 k Ω	$\frac{1}{4}$ W	5%
R37	315-0222-00	2.2 k Ω	$\frac{1}{4}$ W	5%
R42	315-0271-00	270 Ω	$\frac{1}{4}$ W	5%
R43	315-0151-00	150 Ω	$\frac{1}{4}$ W	5%
R45	315-0391-00	390 Ω	$\frac{1}{4}$ W	5%
R49	315-0470-00	47 Ω	$\frac{1}{4}$ W	5%
R55	311-0634-00	500 Ω , Var	$\frac{1}{4}$ W	5%
R56	315-0201-00	200 Ω	$\frac{1}{4}$ W	5%
R58	311-0634-00	500 Ω , Var	$\frac{1}{4}$ W	5%
R59	315-0391-00	390 Ω	$\frac{1}{4}$ W	5%
R61	315-0822-00	8.2 k Ω	$\frac{1}{4}$ W	5%
R63	315-0131-00	130 Ω	$\frac{1}{4}$ W	5%
R65	315-0102-00	1 k Ω	$\frac{1}{4}$ W	5%
R67	315-0301-00	300 Ω	$\frac{1}{4}$ W	5%
R69	303-0471-00	470 Ω	1 W	5%

GENERATOR Circuit Board Assembly (cont)

Ckt. No.	Tektronix Part No.	Serial/Model No. Eff	Disc	Description
Resistors (cont)				
R71	315-0131-00		130 Ω	1/4 W 5%
R73	315-0392-00		3.9 kΩ	1/4 W 5%
R74	315-0122-00		1.2 kΩ	1/4 W 5%
R75	311-0605-00		200 Ω, Var	
R81	321-0094-00		93.1 Ω	1/8 W Prec 1%
R83	315-0201-00		200 Ω	1/4 W 5%
R85	315-0511-00		510 Ω	1/4 W 5%
R87	315-0102-00		1 kΩ	1/4 W 5%
R89	311-0622-00		100 Ω, Var	
R91	301-0132-00		1.3 kΩ	1/2 W 5%
R93	315-0201-00		200 Ω	1/4 W 5%
R95	315-0511-00		510 Ω	1/4 W 5%
R97	301-0102-00		1 kΩ	1/2 W 5%
R101	311-0633-00		5 kΩ, Var	
R103	315-0102-00		1 kΩ	1/4 W 5%
R105	311-0609-00		2 kΩ, Var	
R107	315-0302-00		3 kΩ	1/4 W 5%
R115A,B	311-1033-00		2 x 150 kΩ, Var	
R117	315-0302-00		3 kΩ	1/4 W 5%
R118	311-0633-00		5 kΩ, Var	
R121	301-0132-00		1.3 kΩ	1/2 W 5%
R129	315-0102-00		1 kΩ	1/4 W 5%
R135	315-0201-00		200 Ω	1/4 W 5%
R141	315-0201-00		200 Ω	1/4 W 5%
R143	315-0121-00		120 Ω	1/4 W 5%
R144	321-0094-00		93.1 Ω	1/8 W Prec 1%
R146	315-0101-00		100 Ω	1/4 W 5%
R147	315-0201-00		200 Ω	1/4 W 5%
R149	301-0132-00		1.3 kΩ	1/2 W 5%
R151	315-0511-00		510 Ω	1/4 W 5%
R153	315-0102-00		1 kΩ	1/4 W 5%
R155	311-0622-00		100 Ω, Var	
R156	315-0201-00		200 Ω	1/4 W 5%
R157	315-0511-00		510 Ω	1/4 W 5%
R159	301-0102-00		1 kΩ	1/2 W 5%
R161	311-0633-00		5 kΩ, Var	
R163	315-0102-00		1 kΩ	1/4 W 5%
R165	311-0609-00		2 kΩ, Var	
R167	315-0302-00		3 kΩ	1/4 W 5%
R175A,B	311-1033-00		2 x 150 kΩ, Var	
R177	315-0302-00		3 kΩ	1/4 W 5%
R179	311-0633-00		5 kΩ, Var	
R181	301-0132-00		1.3 kΩ	1/2 W 5%
R183	315-0102-00		1 kΩ	1/4 W 5%
R185	315-0201-00		200 Ω	1/4 W 5%

GENERATOR Circuit Board Assembly (cont)

Ckt. No.	Tektronix Part No.	Serial/Model No. Eff	Disc	Description		
Resistors (cont)						
R187	315-0222-00		2.2 k Ω	1/4 W		5%
R191	315-0201-00		200 Ω	1/4 W		5%
R193	315-0201-00		200 Ω	1/4 W		5%
R195	301-0102-00		1 k Ω	1/2 W		5%
R197	315-0201-00		200 Ω	1/4 W		5%
R199	315-0201-00		200 Ω	1/4 W		5%
R201	323-0135-00		249 Ω	1/2 W	Prec	1%
R203	315-0131-00		130 Ω	1/4 W		5%
R205	315-0131-00		130 Ω	1/4 W		5%
R207	315-0681-00		680 Ω	1/4 W		5%
R209	315-0681-00		680 Ω	1/4 W		5%
R211	301-0911-00		910 Ω	1/2 W		5%
R213	315-0751-00		750 Ω	1/4 W		5%
R215	315-0751-00		750 Ω	1/4 W		5%
R217	315-0131-00		130 Ω	1/4 W		5%
R219	315-0131-00		130 Ω	1/4 W		5%
R221	317-0100-00		10 Ω	1/8 W		5%
R223	317-0100-00		10 Ω	1/8 W		5%
R225	315-0101-00		100 Ω	1/4 W		5%
R227	315-0101-00		100 Ω	1/4 W		5%
R231	323-0090-00		84.5 Ω	1/2 W	Prec	1%
R233	323-0090-00		84.5 Ω	1/2 W	Prec	1%
R237	323-0130-00		221 Ω	1/2 W	Prec	1%
R239	323-0130-00		221 Ω	1/2 W	Prec	1%
R241	315-0391-00		390 Ω	1/4 W		5%
R243	307-0110-00		3 Ω	1/4 W		5%
R245	315-0180-00		18 Ω	1/4 W		5%
R246	315-0391-00		390 Ω	1/4 W		5%
R247	323-0033-00		21.5 Ω	1/2 W	Prec	1%
R248	301-0152-00		1.5 k Ω	1/2 W		5%
R249	323-0033-00		21.5 Ω	1/2 W	Prec	1%
R250	315-0752-00		7.5 k Ω	1/4 W		5%
R252	307-0103-00		2.7 Ω	1/4 W		5%
R254	307-0103-00		2.7 Ω	1/4 W		5%
R261	322-0239-00		3.01 k Ω	1/4 W	Prec	1%
R263	322-0239-00		3.01 k Ω	1/4 W	Prec	1%
R265	322-0210-00		1.5 Ω	1/4 W	Prec	1%
R267	322-0210-00		1.5 Ω	1/4 W	Prec	1%
R268	301-0201-00		200 Ω	1/2 W		5%
R269	323-0105-00		121 Ω	1/2 W	Prec	1%
R270	323-0105-00		121 Ω	1/2 W	Prec	1%
R271	301-0272-00		2.7 k Ω	1/2 W		5%
R273	315-0512-00		5.1 Ω	1/4 W		5%
R275	315-0510-00		51 Ω	1/4 W		5%
R281	301-0101-00		100 Ω	1/2 W		5%

GENERATOR Circuit Board Assembly (cont)

Ckt. No.	Tektronix Part No.	Serial/Model No. Eff	Disc	Description		
Resistors (cont)						
R283	301-0101-00		100 Ω	1/2 W		5%
R285	301-0101-00		100 Ω	1/2 W		5%
R287	301-0101-00		100 Ω	1/2 W		5%
R301	323-0135-00		249 Ω	1/2 W	Prec	1%
R303	315-0131-00		130 Ω	1/4 W		5%
R305	315-0131-00		130 Ω	1/4 W		5%
R307	315-0681-00		680 Ω	1/4 W		5%
R309	315-0681-00		680 Ω	1/4 W		5%
R311	301-0102-00		1 kΩ	1/2 W		5%
R313	315-0221-00		220 Ω	1/4 W		5%
R315	315-0221-00		220 Ω	1/4 W		5%
R317	315-0101-00		100 Ω	1/4 W		5%
R319	315-0101-00		100 Ω	1/4 W		5%
R321	317-0100-00		10 Ω	1/8 W		5%
R323	317-0100-00		10 Ω	1/8 W		5%
R325	315-0101-00		100 Ω	1/4 W		5%
R327	315-0101-00		100 Ω	1/4 W		5%
R331	323-0090-00		84.5 Ω	1/2 W	Prec	1%
R333	323-0090-00		84.5 Ω	1/2 W	Prec	1%
R337	323-0128-00		210 Ω	1/2 W	Prec	1%
R339	323-0128-00		210 Ω	1/2 W	Prec	1%
R341	315-0391-00		390 Ω	1/4 W		5%
R345	315-0200-00		20 Ω	1/4 W		5%
R346	315-0471-00		470 Ω	1/4 W		5%
R347	323-0033-00		21.5 Ω	1/2 W	Prec	1%
R348	301-0152-00		1.5 kΩ	1/2 W		5%
R349	323-0033-00		21.5 Ω	1/2 W	Prec	1%
R350	315-0123-00		12 kΩ	1/4 W		5%
R351	317-0362-00		3.6 Ω	1/8 W		5%
R352	307-0103-00		2.7 Ω	1/4 W		5%
R353	317-0362-00		3.6 Ω	1/8 W		5%
R354	307-0103-00		2.7 Ω	1/4 W		5%
R361	322-0239-00		3.01 kΩ	1/4 W	Prec	1%
R363	322-0239-00		3.01 kΩ	1/4 W	Prec	1%
R365	322-0210-00		1.5 kΩ	1/4 W	Prec	1%
R367	322-0210-00		1.5 kΩ	1/4 W	Prec	1%
R368	301-0201-00		200 Ω	1/2 W		5%
R369	323-0105-00		121 Ω	1/2 W	Prec	1%
R370	323-0105-00		121 Ω	1/2 W	Prec	1%
R371	301-0272-00		2.7 kΩ	1/2 W		5%
R373	315-0512-00		5.1 kΩ	1/4 W		5%
R375	315-0390-00		39 Ω	1/4 W		5%
R381	301-0101-00		100 Ω	1/2 W		5%
R383	301-0101-00		100 Ω	1/2 W		5%
R385	301-0101-00		100 Ω	1/2 W		5%

GENERATOR Circuit Board Assembly (cont)

Ckt. No.	Tektronix Part No.	Serial/Model No. Eff	No. Disc	Description		
Resistors (cont)						
R387	301-0101-00		100 Ω	1/2 W		5%
R411	321-0257-00		4.64 kΩ	1/8 W	Prec	1%
R412	301-0511-00		510 Ω	1/2 W		5%
R413	321-0298-00		12.4 kΩ	1/8 W	Prec	1%
R415	311-0635-00		1 kΩ, Var		Prec	1%
R417	321-0272-00		6.65 kΩ	1/8 W	Prec	1%
R419	321-0329-00		26.1 kΩ	1/8 W	Prec	1%
R421	321-0239-00		3.01 kΩ	1/8 W	Prec	1%
R423	308-0441-00		3 Ω	3 W	WW	5%
R427	315-0152-00		1.5 kΩ	1/4 W		5%
R429	315-0272-00		2.7 kΩ	1/4 W		5%
R431	321-0257-00		4.64 kΩ	1/8 W	Prec	1%
R432	301-0511-00		510 Ω	1/2 W		5%
R433	321-0298-00		12.4 kΩ	1/8 W	Prec	1%
R435	311-0635-00		1 kΩ, Var			
R437	321-0272-00		6.65 kΩ	1/8 W	Prec	1%
R439	321-0329-00		26.1 kΩ	1/8 W	Prec	1%
R441	321-0239-00		3.01 kΩ	1/8 W	Prec	1%
R442	308-0441-00		3 Ω	3 W	WW	5%
R443	301-0511-00		510 Ω	1/2 W		5%
R444	315-0102-00		1 kΩ	1/4 W		5%
R445	308-0542-00		500 Ω	3 W	WW	1/10%
R447	308-0218-00		150 Ω	3 W	WW	5%
R449	301-0271-00		270 Ω	1/2 W		5%

Switches

Wired or Unwired

S40 ²	*670-1167-00	Cam	PERIOD
S100 ²	*670-1167-00	Cam	DELAY
S160 ²	*670-1167-00	Cam	PULSE DURATION

Integrated Circuits

U10	156-0054-00	Dual 4 input clock driver. Replaceable by Motorola MC1006L
U410	156-0053-00	Volt reg Replaceable by Fairchild μA 723C
U430	156-0053-00	Volt reg Replaceable by Fairchild μA 723C

²See Mechanical Parts List for replacement parts.



SECTION 7 DIAGRAMS AND MECHANICAL PARTS ILLUSTRATIONS

The following special symbols are used on the diagrams:

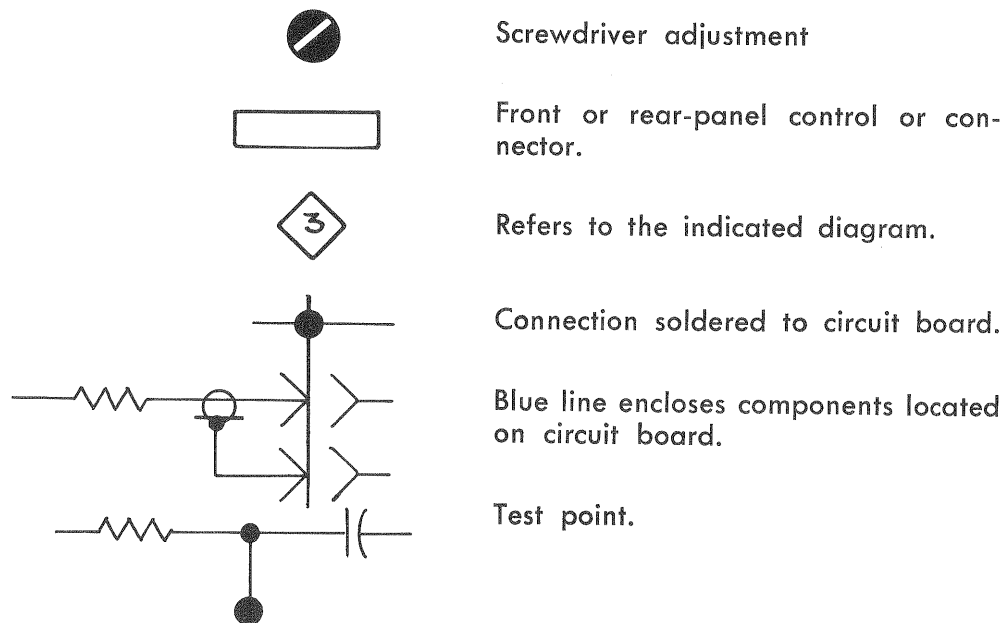

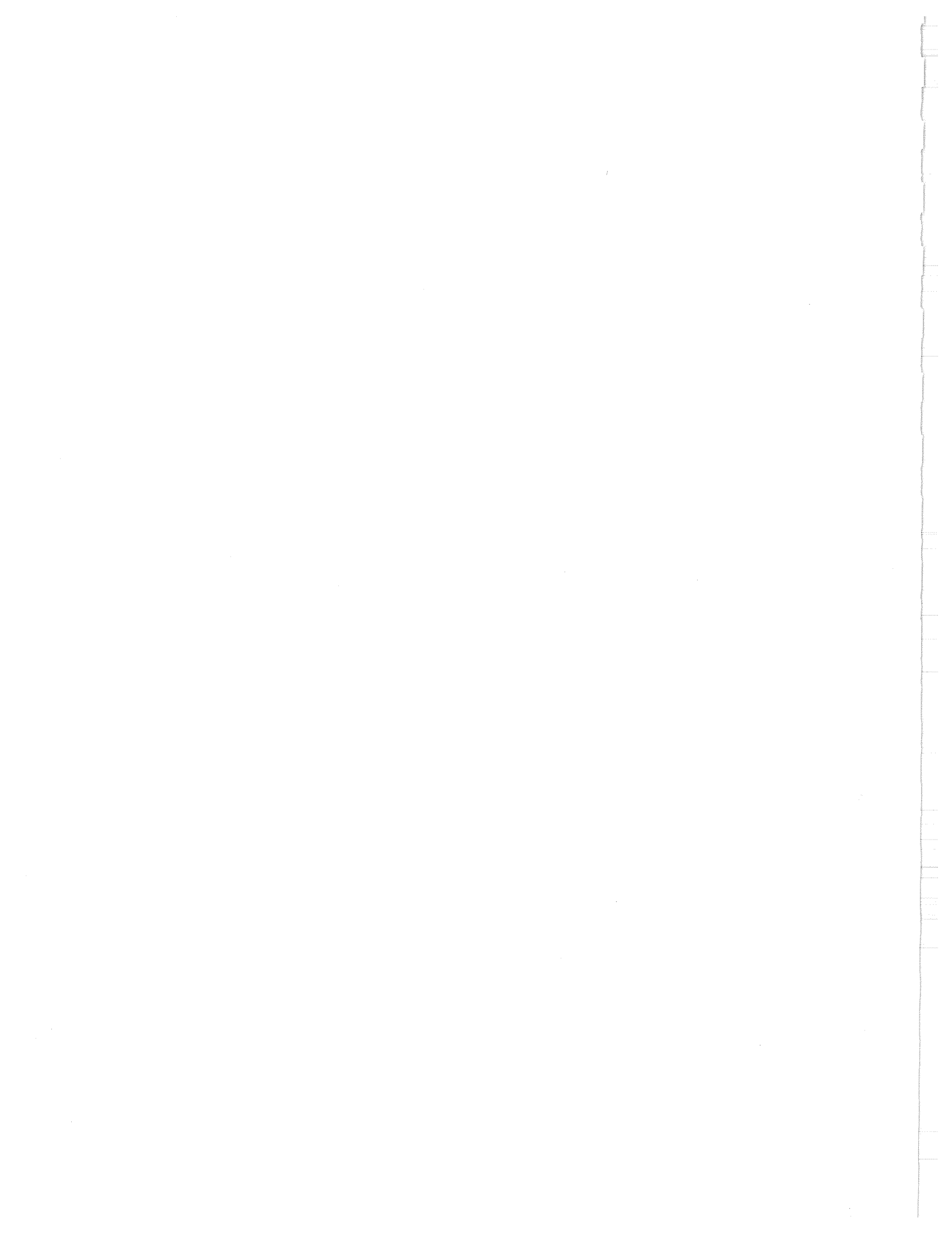

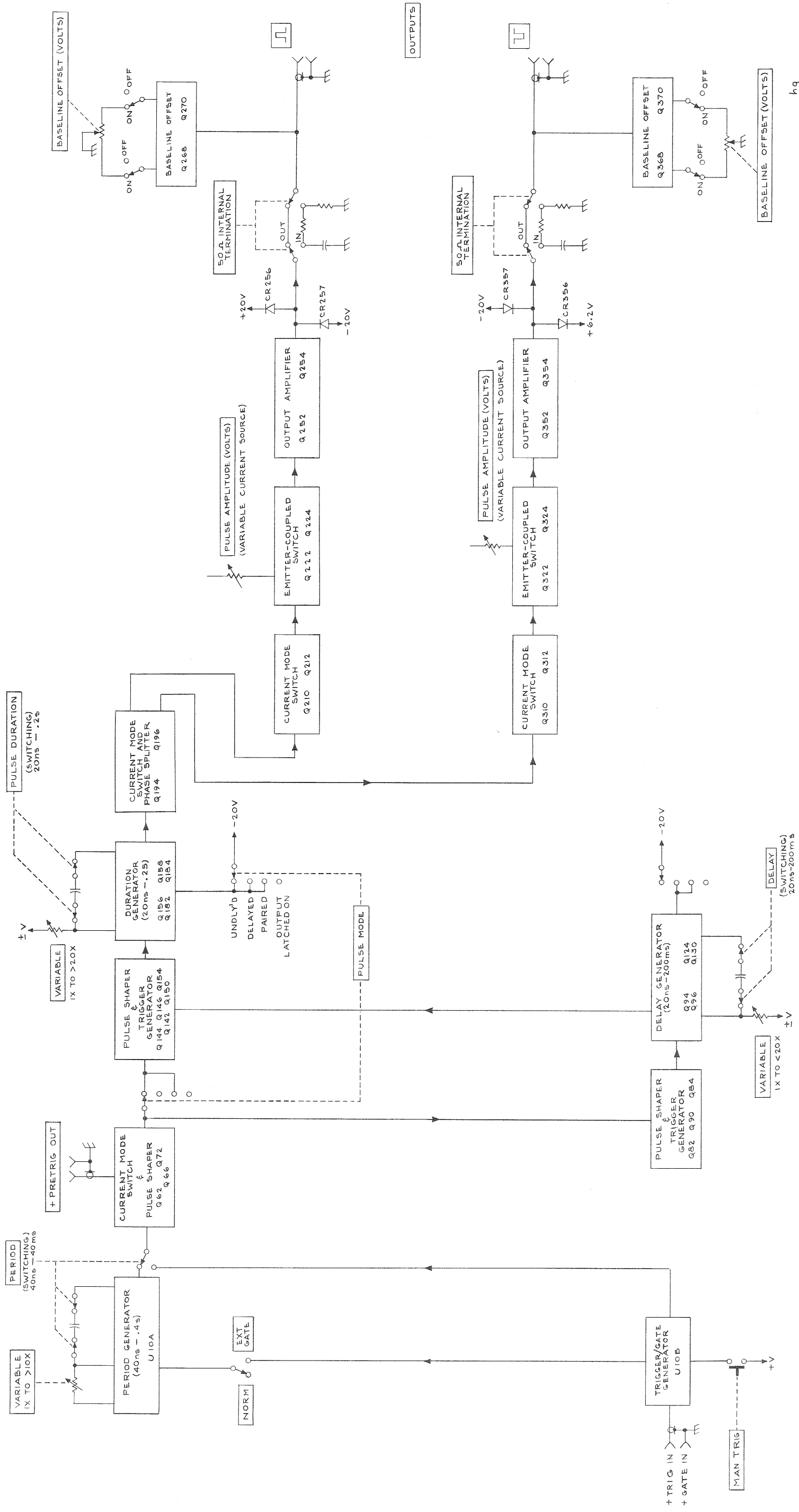

2101 PULSE GENERATOR

(A)

BLOCK DIAGRAM

h9
0470

VOLTAGE AND WAVEFORM TEST CONDITIONS

Typical voltage measurements and waveform photographs (shown in blue) were obtained using equipment with the following characteristics.

Test oscilloscope: Bandpass DC to 150 MHz, with high impedance (10 M Ω), low capacitance (10 pF) probe; such as Tektronix Type 454 with a P6047 probe, or a Tektronix 7704 with 7A16 and 7B70 plug-in units plus a P6053 probe. A Tektronix sampling system, such as a Type 561 oscilloscope with 3S1 and 3T77A plug-in units plus P6055 or P6034 probes, may also be used provided an input coupling capacitor (such as GR Type 874) is used to couple the probe to the low impedance input of the sampling amplifier.

DC Voltmeter: Non-loading, such as a VTVM. A high-sensitivity (20,000 ohms/volt) voltohmmeter such as Triplett Model 630 or Simpson Model 262 can be used.

Tektronix Trace Recording Camera System.

The test oscilloscope is triggered externally from the 2101 (+PRETRIG OUT signal) to indicate the time relationship between signals. The probe ground must be the most direct and shortest route to chassis or circuit board ground. Time/Div and Volts/Div settings are shown on each waveform.

The 2101 Pulse Generator control setup, with exceptions noted on the waveform diagrams is as follows:

PULSE MODE	PAIRED
PERIOD	.4 μ s
PULSE DURATION	.2 μ s
DELAY	500 ns (approximately)
NORM EXT GATED	NORM
PULSE AMPLITUDE	Fully clockwise
BASELINE OFFSET	OFF
50 Ω INTERNAL TERMINATION	IN

Both OUTPUT and +PRETRIG OUT connectors must be terminated into 50 Ω .

Voltages and waveforms on the diagrams are not absolute but will vary because of test equipment and 2101 tolerances. They are intended as aids for troubleshooting and circuit understanding.

CAUTION

The shield of the coaxial leads from the Mode switch (white with orange and white with yellow tracer) are connected to -5.1-volt supply. Do not connect the probe ground to these shields.



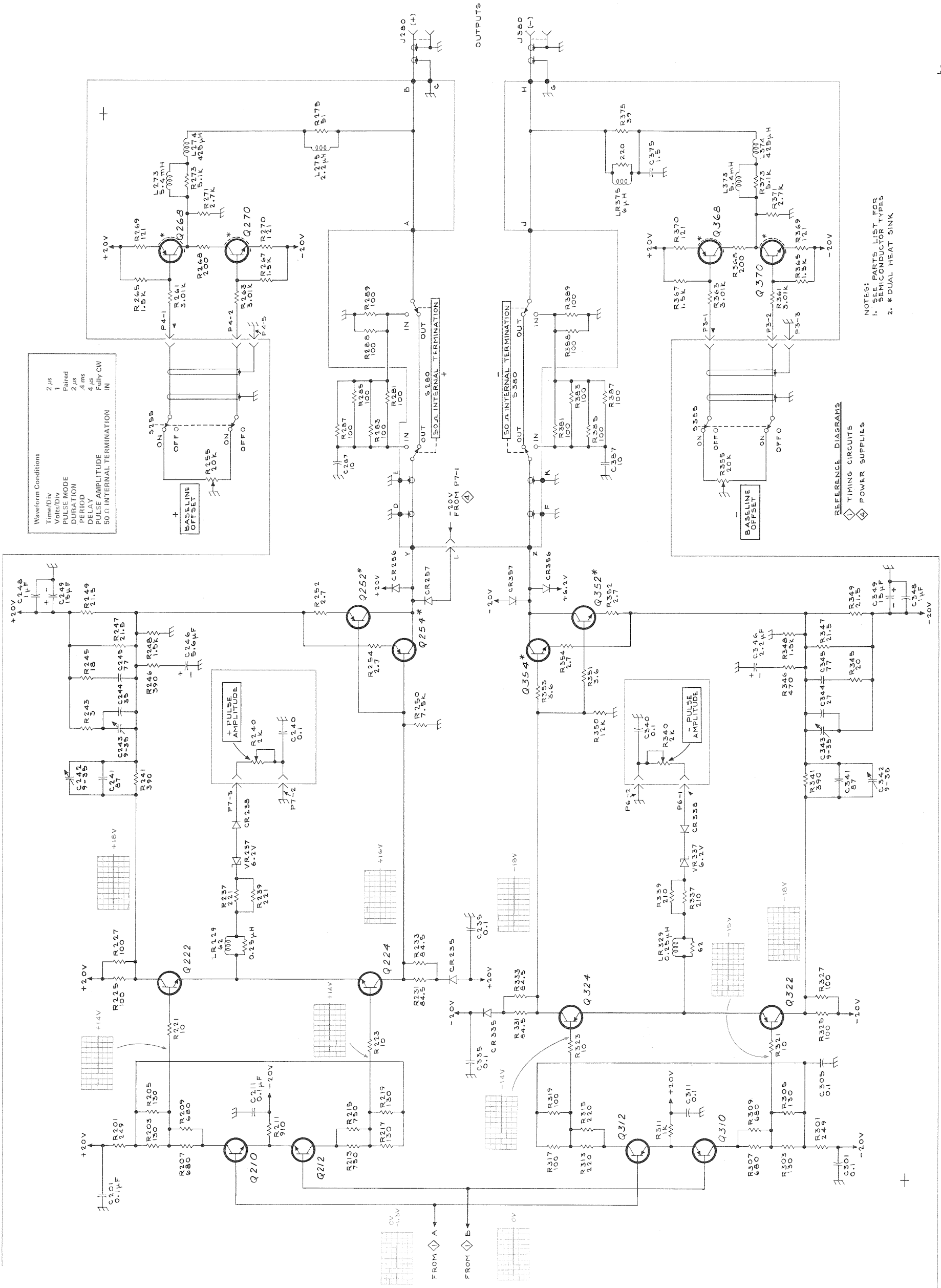

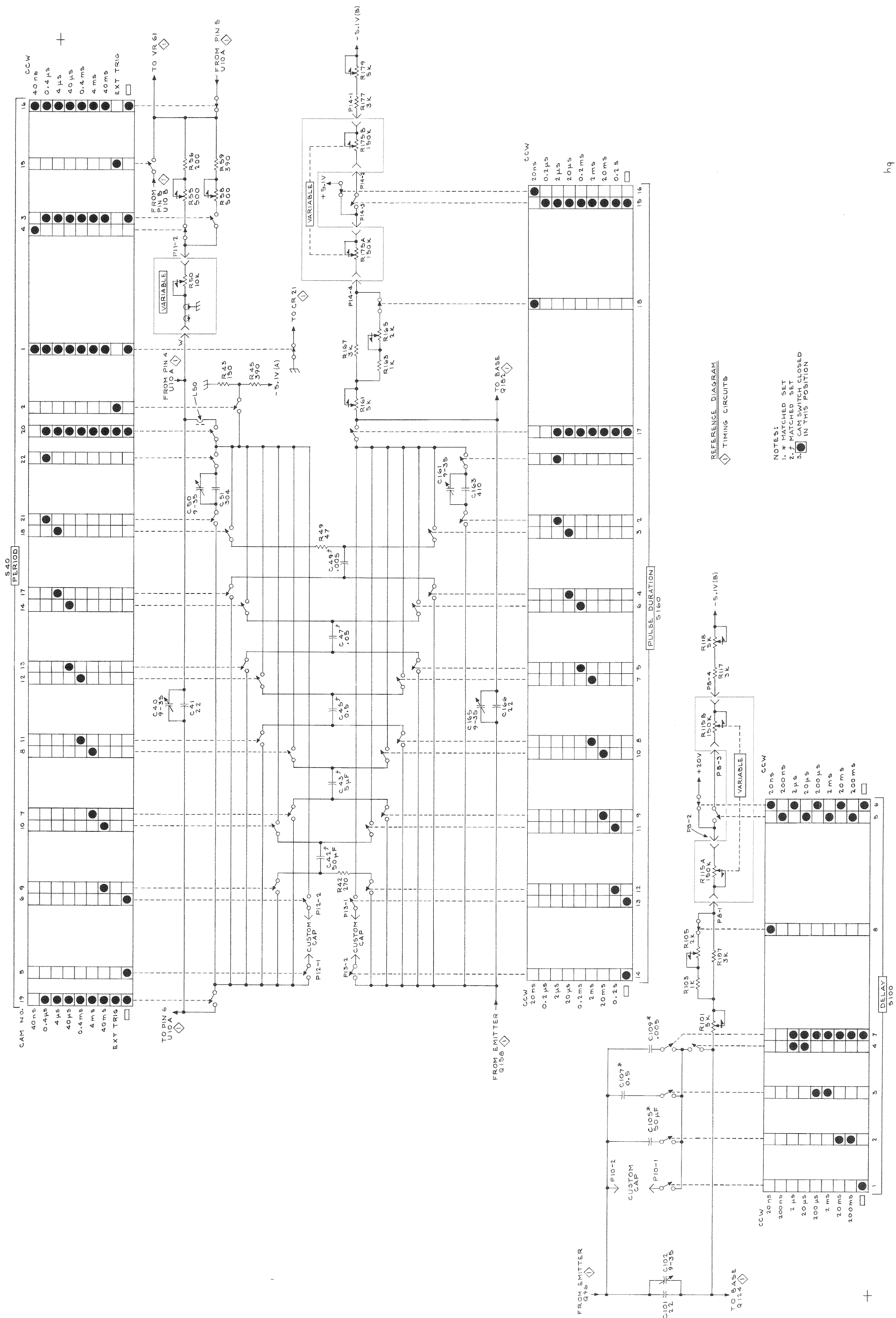

REFERENCE DIAGRAM
 ① TIMING CIRCUITS

NOTES:
 1. * MATCHED SET
 2. / MATCHED SET
 3. / MATCHED SET
 4. IN THIS POSITION

CARTON ASSEMBLY
(Part No. 065-0134-00)

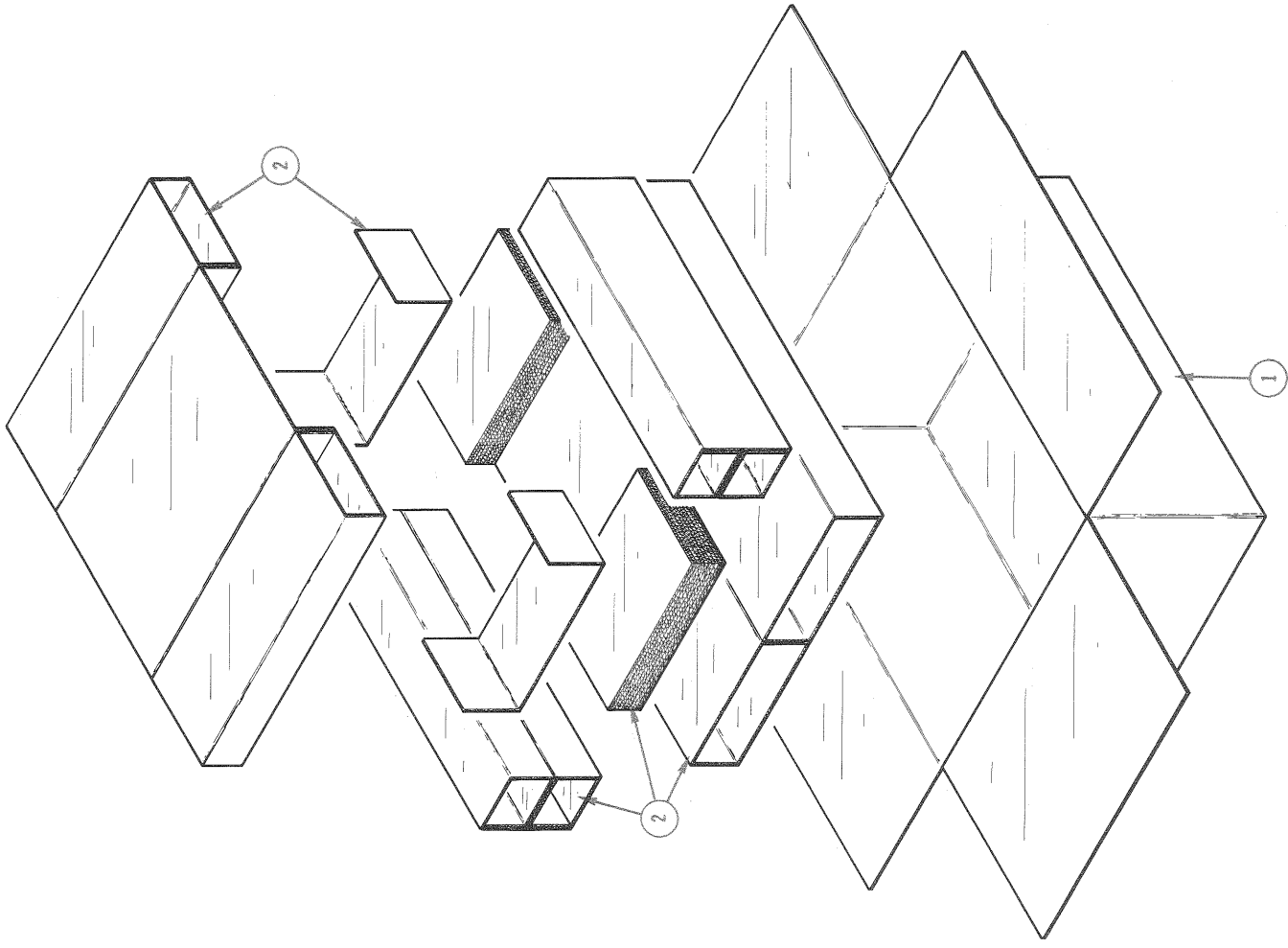

Fig. & Index No.	Tektronix Part No.	Serial/Model No. Eff	Disc	Q					Description	
				Y	1	2	3	4		5
2-	065-0134-00			1						CARTON ASSEMBLY
-1	004-0682-00									assembly includes:
-2	004-1072-00									CARTON PAD SET

2101 PULSE GENERATOR

FIGURE AND INDEX NUMBERS

Items in this section are referenced by figure and index numbers to the illustrations which appear either on the back of the diagrams or on pullout pages immediately following the diagrams of the instruction manual.

INDENTATION SYSTEM

This mechanical parts list is indented to indicate item relationships. Following is an example of the indentation system used in the Description column.

Assembly and/or Component
Detail Part of Assembly and/or Component
mounting hardware for Detail Part
Parts of Detail Part
mounting hardware for Parts of Detail Part
mounting hardware for Assembly and/or Component

Mounting hardware always appears in the same indentation as the item it mounts, while the detail parts are indented to the right. Indented items are part of, and included with, the next higher indentation.

Mounting hardware must be purchased separately, unless otherwise specified.

PARTS ORDERING INFORMATION

Replacement parts are available from or through your local Tektronix, Inc. Field Office or representative.

Changes to Tektronix instruments are sometimes made to accommodate improved components as they become available, and to give you the benefit of the latest circuit improvements developed in our engineering department. It is therefore important, when ordering parts, to include the following information in your order: Part number, instrument type or number, serial or model number, and modification number if applicable.

If a part you have ordered has been replaced with a new or improved part, your local Tektronix, Inc. Field Office or representative will contact you concerning any change in part number.

Change information, if any, is located at the rear of this manual.

ABBREVIATIONS AND SYMBOLS

For an explanation of the abbreviations and symbols used in this section, please refer to the page immediately preceding the Electrical Parts List in this instruction manual.

INDEX OF MECHANICAL & REPACKAGING PARTS ILLUSTRATIONS

Title	Location (reverse side of)
Figure 1 Exploded & Standard Accessories	Timing Switches Diagram
Figure 2 Repackaging	Power Supplies Diagram

SECTION 8

MECHANICAL PARTS LIST

FIGURE 1 EXPLODED

Fig & Index No.	Tektronix Part No.	Serial/Model Eff	No. Disc	Q					Description	
				t	y	1	2	3		4
1-1	670-1167-00			1						CIRCUIT BOARD ASSEMBLY—GENERATOR
	- - - - -			-						circuit board assembly includes:
	388-1474-00			1						CIRCUIT BOARD
-2	131-0589-00			60						TERMINAL, pin, 0.50 inch long
-3	131-0604-00			48						CONTACT, electrical
	131-0792-01			3						TERMINAL CONNECTOR ASSEMBLY
	- - - - -			-						each terminal connector assembly includes:
-4	131-0792-00			2						CONNECTOR, terminal
-5	176-0003-00			ft						WIRE, tinned copper, #18SWG, 1.75 inches
-6	352-0198-00			1						HOLDER, terminal connector, 2 wire
-7	136-0220-00			29						SOCKET, transistor, 3 pin, square
-8	136-0183-00			11						SOCKET, transistor, 3 pin
-9	136-0241-00			2						SOCKET, integrated circuit, 10 contact
-10	136-0269-00			1						SOCKET, integrated circuit, 14 contact
-11	214-0579-00			5						PIN, test point
-12	214-0798-00			2						HEAT SINK, transistor, double
	- - - - -			-						mounting hardware for each: (not included w/heat sink)
-13	211-0014-00			2						SCREW, 4-40 x 0.50 inch, PHS
	210-0823-00			2						WASHER, fiber, 0.14 ID x 0.25 inch OD
-14	214-1300-00			4						HEAT SINK, transistor
	- - - - -			-						mounting hardware for each: (not included w/heat sink)
-15	211-0014-00			2						SCREW, 4-40 x 0.50 inch, PHS
-16	210-0823-00			2						WASHER, fiber, 0.14 ID x 0.25 inch OD
-17	337-1249-00			2						SHIELD, electrical
-18	407-0725-00			2						BRACKET, component mounting
-19	- - - - -			2						RESISTOR, variable
	- - - - -			-						mounting hardware for each: (not included w/resistor)
-20	210-0583-00			1						NUT, hex., 4-32 x 0.312 inch
-21	210-0940-00			1						WASHER, flat, 0.25 ID x 0.375 inch OD
-22	210-0046-00			1						WASHER, lock, internal, 0.261 ID x 0.40 inch OD
-23	200-1077-00			1						COVER, cam switch
	- - - - -			-						mounting hardware: (not included w/cover)
-24	211-0022-00			3						SCREW, 2-56 x 0.188 inch, PHS
-25	210-0001-00			3						WASHER, lock, internal, 0.092 ID x 0.18 inch OD
-26	210-0405-00			3						NUT, hex., 2-56 x 0.188 inch
-27	200-1078-00			1						COVER, cam switch
	- - - - -			-						mounting hardware: (not included w/cover)
-28	211-0022-00			2						SCREW, 2-56 x 0.188 inch, PHS
-29	210-0001-00			2						WASHER, lock, internal, 0.092 ID x 0.18 inch OD
-30	210-0405-00			2						NUT, hex., 2-56 x 0.188 inch

FIGURE 1 EXPLODED (cont)

Fig & Index No.	Tektronix Part No.	Serial/Model Eff	No. Disc	Q					Description	
				y	1	2	3	4		5
1-31	105-0162-00			1						DRUM, cam switch—WIDTH
-32	105-0166-00			1						DRUM, cam switch—PERIOD
-33	105-0165-00			1						DRUM, cam switch—DELAY
-34	401-0058-00			3						BEARING, cam switch, front
				-						mounting hardware for each: (not included w/bearing)
-35	211-0116-00			2						SCREW, sems 4-40 x 0.312 inch, PHB
-36	210-0406-00			2						NUT, hex., 4-40 x 0.188 inch
-37	401-0061-00			2						BEARING, cam switch, rear
				-						mounting hardware for each: (not included w/bearing)
	211-0116-00			2						SCREW, sems, 4-40 x 0.312 inch, PHB
-38	210-0406-00			2						NUT, hex., 4-40 x 0.188 inch
-39	354-0219-00			3						RING, retaining
-40	407-0714-00			2						BRACKET, grounding
-41	214-1126-00 ¹			-						SPRING, flat, detent, gold
	214-1126-01 ¹			-						SPRING, flat, detent, green
	214-1126-02 ¹			-						SPRING, flat, detent, red
-42	214-1127-00			3						ROLLER, detent
				-						mounting hardware: (not included w/circuit board assembly)
-43	211-0116-00			11						SCREW, sems, 4-40 x 0.312 inch, PHB
-44	366-1023-00			1						KNOB, gray—VARIABLE PERIOD
				-						knob includes:
	213-0153-00			1						SETSCREW, 5-40 x 0.125 inch, HSS
-45	366-1023-00			1						KNOB, gray—VARIABLE PULSE DURATION
				-						knob includes:
	213-0153-00			1						SETSCREW, 5-40 x 0.125 inch, HSS
-46	366-1023-00			1						KNOB gray—VARIABLE DELAY
				-						knob includes:
	213-0153-00			1						SETSCREW, 5-40 x 0.125 inch, HSS
-47	366-1023-00			1						KNOB, gray—PULSE AMPLITUDE —
				-						knob includes:
	213-0153-00			1						SETSCREW, 5-40 x 0.125 inch, HSS
-48	366-1023-00			1						KNOB, gray—PULSE AMPLITUDE +
				-						knob includes:
	213-0153-00			1						SETSCREW, 5-40 x 0.125 inch, HSS
-49	366-1202-00			1						KNOB gray—PULSE DURATION
				-						knob includes
	213-0153-00			1						SETSCREW, 5-40 x 0.125 inch, HSS
-50	366-1201-00			1						KNOB, gray—PERIOD
				-						knob includes:
	213-0153-00			1						SETSCREW, 5-40 x 0.125 inch, HSS
-51	366-1209-00			1						KNOB, gray—DELAY
				-						knob includes:
	213-0153-00			1						SETSCREW, 5-40 x 0.125 inch, HSS
-52	366-1207-00			1						KNOB, gray—BASELINE OFFSET —
				-						knob includes:
	213-0153-00			1						SETSCREW, 5-40 x 0.125 inch, HSS
-53	366-1207-00			1						KNOB, gray—BASELINE OFFSET +
				-						knob includes:
	213-0153-00			1						SETSCREW, 5-40 x 0.125 inch, HSS
-54	366-0215-02			1						KNOB, lever—PULSE MODE
-55	131-0955-00			4						CONNECTOR, receptacle, female BNC, w/hardware
				-						mounting hardware for each: (not included w/connector)
-56	210-0255-00			1						LUG, solder, 0.375 inch

¹Replace only with part bearing same color code as the original part in your instrument.

FIGURE 1 EXPLODED (cont)

Fig & Index No.	Tektronix Part No.	Serial/Model No. Eff	No. Disc	Q					Description	
				y	1	2	3	4		5
1-57	136-0223-00			1						SOCKET, light—POWER
	- - - - -			-						socket includes:
-58	210-0562-00			1						NUT, hex., 0.25-40 x 0.312 inch
	- - - - -			-						mounting hardware: (not included w/socket)
-59	210-0046-00			1						WASHER, lock, internal, 0.261 ID x 0.40 inch OD
-60	260-0247-00			1						SWITCH, pushbutton—MAN TRIG
	- - - - -			-						mounting hardware: (not included w/switch)
-61	210-0583-00			1						NUT, hex., 0.25-32 x 0.312 inch
	210-0940-00			1						WASHER, flat, 0.25 ID x 0.375 inch OD
-62	210-0046-00			1						WASHER, lock, internal, 0.261 ID x 0.40 inch OD
-63	333-1262-00			1						PANEL, front
-64	260-0834-00			1						SWITCH, toggle—POWER
	- - - - -			-						mounting hardware: (not included w/switch)
-65	210-0562-00			1						NUT, hex., 0.25-40 x 0.312 inch
-66	210-0046-00			1						WASHER, lock, internal, 0.261 ID x 0.40 inch OD
-67	260-1120-00			1						SWITCH, lever—PULSE MODE
	- - - - -			-						mounting hardware: (not included w/switch)
-68	210-0586-00			2						NUT, keps, 4-40 x 0.25 inch
-69	211-0038-00			2						SCREW, 4-40 x 0.312 inch 100° csk FHS
-70	210-0202-00			1						LUG, solder, SE #6
	- - - - -			-						mounting hardware: (not included w/lug)
-71	211-0541-00			1						SCREW 6-32 x 0.25 inch, 100° csk, FHS
-72	210-0407-00			1						NUT, hex., 6-32 x 0.25 inch
-73	210-0204-00			1						LUG, solder, DE #6
	- - - - -			-						mounting hardware: (not included w/lug)
-74	211-0541-00			1						SCREW, 6-32 x 0.25 inch, 100° csk, FHS
-75	210-0407-00			1						NUT, hex., 6-32 x 0.25 inch
-76	260-0816-00			1						SWITCH, slide—50 Ω INTERNAL TERMINATION +
	- - - - -			-						mounting hardware: (not included w/switch)
-77	210-0405-00			2						NUT, hex., 2-56 x 0.188 inch
-78	211-0030-00			2						SCREW, 2-56 x 0.25 inch, 82° csk, FHS
-79	260-0816-00			1						SWITCH, slide—BASELINE OFFSET +
	- - - - -			-						mounting hardware: (not included w/switch)
	210-0405-00			2						NUT, hex., 2-56 x 0.188 inch
	211-0030-00			2						SCREW, 2-56 x 0.25 inch, 82° csk, FHS

FIGURE 1 EXPLODED (cont)

Fig & Index No.	Tektronix Part No.	Serial/Model Eff	No. Disc	Q t y					Description
				1	2	3	4	5	
1-80	260-0816-00			1					SWITCH, slide—BASELINE OFFSET — - mounting hardware: (not included w/switch)
	210-0405-00			2					NUT, hex., 2-56 x 0.188 inch
	211-0030-00			2					SCREW, 2-56 x 0.25 inch, 82° csk, FHS
-81	260-0816-00			1					SWITCH, slide—50 Ω INTERNAL TERMINATION — - mounting hardware: (not included w/switch)
	210-0405-00			2					NUT, hex., 2-56 x 0.188 inch
	211-0030-00			2					SCREW, 2-56 x 0.25 inch, 82° csk, FHS
-82	260-0816-00			1					SWITCH, slide—NORM-EXT GATED MODE - mounting hardware: (not included w/switch)
	210-0405-00			2					NUT, hex., 2-56 x 0.188 inch
	211-0030-00			2					SCREW, 2-56 x 0.25 inch, 82° csk, FHS
-83	131-0775-00			1					TERMINAL, stud - mounting hardware: (not included w/terminal)
-84	211-0502-00			1					SCREW, 6-32 x 0.188 inch, 100° csk, FHS
-85				5					RESISTOR, variable - mounting hardware for each: (not included w/resistor)
	213-0178-00			1					SETSCREW, 4-40 x 0.125 inch, HSS
-86	386-1752-00			1					SUBPANEL, front - mounting hardware: (not included w/subpanel)
-87	211-0541-00			4					SCREW, 6-32 x 0.25 inch, 100° csk, FHS
-88	384-0394-00			1					ROD, extension, shaft, 7.25 inches long
-89	384-0461-00			1					EXTENSION SHAFT, 3.25 inches long
-90	384-0289-00			1					ROD, shaft, switch, 2.813 inches long - mounting hardware: (not included w/rod)
	213-0178-00			2					SETSCREW, 4-40 x 0.125 inch, HSS
-91	376-0051-00			2					COUPLER, shaft - each coupler includes:
	213-0178-00			4					SETSCREW, 4-40 x 0.125 inch, HSS
-92	407-0756-00			1					BRACKET, angle, right - mounting hardware: (not included w/bracket)
-93	210-0586-00			4					NUT, keps, 4-40 x 0.25 inch
-94	407-0757-00			1					BRACKET, angle, left - mounting hardware: (not included w/bracket)
-95	210-0586-00			4					NUT, keps, 4-40 x 0.25 inch

FIGURE 1 EXPLODED (cont)

Fig & In dex No.	Tektronix Part No.	Serial/Model Eff	No. Disc	Q					Description	
				f	y	1	2	3		4
1-96	426-0638-00			1						FRAME SECTION, right
-97	426-0644-00			1						FRAME SECTION, left
-98	210-0202-00			1						LUG, solder, SE #6
	- - - - -			-						mounting hardware: (not included w/lug)
-99	210-0457-00			1						NUT, keps, 6-32 x 0.312 inch
-100	211-0507-00			1						SCREW, 6-32 x 0.312 inch, PHS
-101	343-0136-00			1						CLAMP, loop, cable
	- - - - -			-						mounting hardware: (not included w/clamp)
	211-0510-00			1						SCREW, 6-32 x 0.375 inch, PHS
-102	210-0853-00			1						WASHER, D shape, #10
-103	210-0457-00			1						NUT, keps, 6-32 x 0.312 inch
-104	200-0260-00			2						COVER, capacitor, 2.031 inches long
-105	- - - - -			2						CAPACITOR
	- - - - -			-						mounting hardware for each: (not included w/capacitor)
-106	211-0507-00			2						SCREW, 6-32 x 0.312 inch, PHS
-107	386-0254-00			1						PLATE, fiber, large
-108	210-0457-00			2						NUT, keps, 6-32 x 0.312 inch
-109	- - - - -			1						THERMO CUTOUT
	- - - - -			-						mounting hardware: (not included w/thermo cutout)
-110	211-0507-00			2						SCREW, 6-32 x 0.312 inch, PHS
-111	210-0457-00			2						NUT, keps, 6-32 x 0.312 inch
-112	131-0761-00			2						TERMINAL, post
	- - - - -			-						mounting hardware for each: (not included w/terminal)
-113	211-0503-00			1						SCREW, 6-32 x 0.188 inch, PHS
-114	441-0912-00			1						CHASSIS
	- - - - -			-						mounting hardware: (not included w/chassis)
-115	211-0008-00			4						SCREW, 4-40 x 0.25 inch, PHS
-116	200-0704-00			1						COVER, line voltage selector
	- - - - -			-						cover includes:
-117	352-0102-00			2						HOLDER, fuse, plastic
	- - - - -			-						mounting hardware for each: (not included w/holder)
-118	213-0035-00			2						SCREW, thread cutting, 4-40 x 0.25 inch, PHS
-119	204-0279-00			1						BODY, line voltage
	- - - - -			-						mounting hardware: (not included w/body)
-120	210-0407-00			2						NUT, hex., 6-32 x 0.25 inch
	210-0006-00			2						WASHER, lock, internal, #6

FIGURE 1 EXPLODED (cont)

Fig & Index No.	Tektronix Part No.	Serial/Model Eff	No. Disc	Q f y	1 2 3 4 5					Description
					1	2	3	4	5	
1-121	- - - - -			1						TRANSFORMER
	- - - - -			-						mounting hardware: (not included w/transformer)
-122	212-0590-00			4						SCREW, 10-32 x 1.50 inches, HHS
-123	210-0805-00			4						WASHER, flat, 0.204 ID x 0.438 inch OD
-124	166-0432-00			4						TUBE, bolt insulator
-125	210-0812-00			4						WASHER, fiber, #10
-126	220-0410-00			4						NUT, hex., 10-32 x 0.375 inch
-127	200-0379-00			1						COVER, transformer
-128	200-0669-00			2						COVER, transistor
	- - - - -			-						mounting hardware for each: (not included w/transistor)
-129	211-0511-00			1						SCREW, 6-32 x 0.50 inch, PHS
-130	210-0935-00			1						WASHER, fiber, 0.14 ID x 0.375 inch OD
-131	210-0803-00			1						WASHER, flat, 0.15 ID x 0.375 inch OD
-132	210-0457-00			1						NUT, keps, 6-32 x 0.312 inch
-133	- - - - -			2						TRANSISTOR
	- - - - -			-						mounting hardware for each: (not included w/transistor)
-134	211-0510-00			1						SCREW, 6-32 x 0.375 inch, PHS
-135	386-0978-00			1						PLATE, mica, 1.17 x 1.70 inches
-136	210-0935-00			1						WASHER, fiber, 0.14 ID x 0.375 inch OD
	210-0803-00			1						WASHER, flat, 0.15 ID x 0.375 inch OD
-137	210-0202-00			1						LUG, solder, SE #6
-138	210-0457-00			1						NUT, keps, 6-32 x 0.312 inch
-139	333-1328-00			1						PANEL, rear
-140	386-1753-00			1						SUBPANEL, rear
	- - - - -			-						mounting hardware: (not included w/subpanel)
-141	211-0541-00			4						SCREW, 6-32 x 0.25 inch, 100° csk, FHS
-142	179-1505-00			1						WIRING HARNESS, main
	- - - - -			-						wiring harness includes:
-143	131-0621-00			16						CONNECTOR, terminal
-144	131-0622-00			6						CONNECTOR, terminal
-145	131-0792-00			2						CONNECTOR, terminal
-146	352-0198-00			2						HOLDER, terminal connector, 2 wire
-147	352-0199-00			1						HOLDER, terminal connector, 3 wire
-148	352-0200-00			1						HOLDER, terminal connector, 4 wire
-149	352-0204-00			1						HOLDER, terminal connector, 8 wire
	179-1508-00			1						WIRING HARNESS, offset
	- - - - -			-						wiring harness includes:
	131-0621-00			5						CONNECTOR, terminal
	131-0622-00			2						CONNECTOR, terminal
	352-0199-00			2						HOLDER, terminal connector, 3 wire

FIGURE 1 EXPLODED (cont)

Fig & Index No.	Tektronix Part No.	Serial/Model No. Eff	No. Disc	Q † y	1 2 3 4 5					Description
					1	2	3	4	5	
1-	179-1507-00			1						WIRING HARNESS, AC
	- - - - -			-						wiring harness includes:
	214-0768-00			8						CONNECTOR, terminal
	179-1503-00			1						WIRING HARNESS, bracket
	- - - - -			-						wiring harness includes:
	131-0621-00			15						CONNECTOR, terminal
-150	352-0204-00			1						HOLDER, terminal connector, 5 wire
-151	352-0206-00			1						HOLDER, terminal connector, 10 wire
	175-1156-00			2						CABLE ASSEMBLY, special purpose
	- - - - -			-						cable assembly includes:
-152	175-0827-00			ft						WIRE, electrical, ribbon, 4 wire, 3 inches long
	131-0621-00			4						CONNECTOR, terminal
	352-0200-00			1						HOLDER, terminal connector, 4 wire
-153	344-0208-01			2						CLIP
-154	367-0037-00			1						HANDLE, carrying
	- - - - -			-						mounting hardware: (not included w/handle)
-155	213-0155-00			2						SCREW, 10-32 x 0.40 inch
-156	390-0153-00			1						CABINET TOP
	- - - - -			-						cabinet top includes:
	214-0812-00			4						LATCH ASSEMBLY
	- - - - -			-						each latch assembly includes:
-157	214-0603-01			1						PIN, securing
-158	214-0604-00			1						SPRING, latch
-159	386-0227-00			1						PLATE, index
-160	386-0226-00			1						PLATE, locking
-161	390-0154-00			1						CABINET BOTTOM
	- - - - -			-						cabinet bottom includes:
-162	214-0812-00			4						LATCH ASSEMBLY
	- - - - -			-						each latch assembly includes:
	214-0603-01			1						PIN, securing
	214-0604-00			1						SPRING, latch
	386-0227-00			1						PLATE, index
	386-0226-00			1						PLATE, locking
-163	348-0255-00			2						FOOT, cabinet
	- - - - -			-						mounting hardware for each: (not included w/foot)
-164	211-0507-00			3						SCREW, 6-32 x 0.312 inch, PHS
-165	220-0419-00			3						NUT, square, 6-32 x 0.312 inch
-166	348-0257-00			1						FLIP-STAND, cabinet
-167	348-0254-00			4						PAD, cabinet foot
-168	358-0161-00			1						BUSHING, strain relief
-169	161-0049-00			1						CABLE ASSEMBLY, power

STANDARD ACCESSORIES

-170	011-0049-01			2						TERMINATION, coaxial, 50 ohm
-171	012-0117-00			3						CABLE ASSEMBLY, RF, RG, 55/U, BNC
	070-1029-00			2						MANUAL, instruction (not shown)

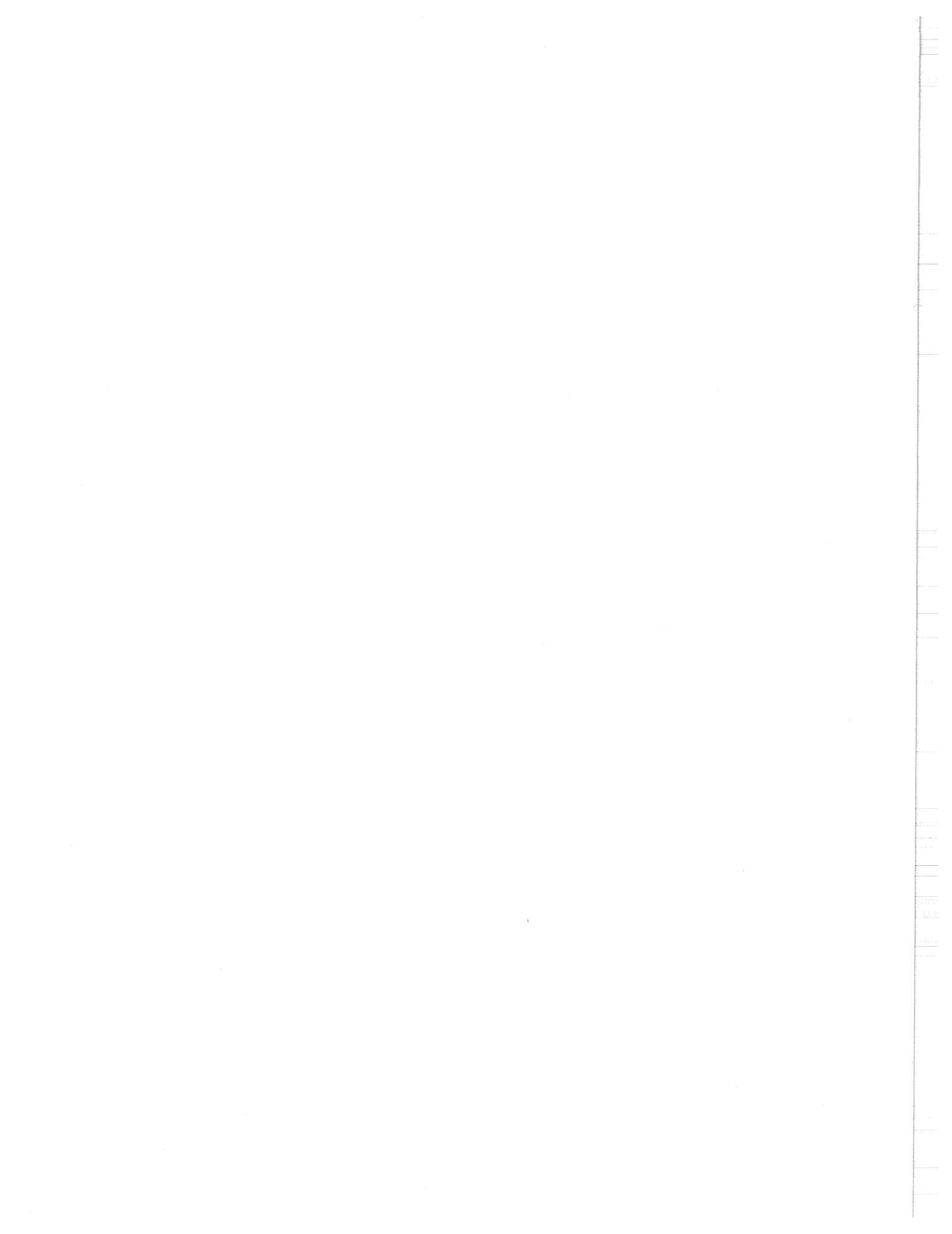

MANUAL CHANGE INFORMATION

At Tektronix, we continually strive to keep up with latest electronic developments by adding circuit and component improvements to our instruments as soon as they are developed and tested.

Sometimes, due to printing and shipping requirements, we can't get these changes immediately into printed manuals. Hence, your manual may contain new change information on following pages.

A single change may affect several sections. Sections of the manual are often printed at different times, so some of the information on the change pages may already be in your manual. Since the change information sheets are carried in the manual until ALL changes are permanently entered, some duplication may occur. If no such change pages appear in this section, your manual is correct as printed.

TEXT CORRECTIONS

Section 1 Specifications

Page 1-1 Electrical Characteristics

CHANGE: Pulse Period Accuracy to read:

Within 5% of selector indication plus 3 ns, except 40 ms period which is 10%. PERIOD VARIABLE at the 1X position.

CHANGE: Pulse Duration Accuracy to read:

Within 5% of selector indication plus 3 ns, except 0.2 s duration which is 10%. DURATION VARIABLE at 1X position. At pulse amplitudes below 2 volts (40 mA), duration accuracy is within 5%, +3 ns, -7 ns.

CHANGE: Pulse Delay Accuracy to read:

Within 5% of selector indication plus 3 ns, except 200 ms delay which is 10%. DELAY VARIABLE in 1X position.

Section 5 Performance Check/Calibration

Page 5-10 Table 5-2

CHANGE: Tolerance for 40 ms Period to $\pm 4/\text{Period}$.

Tolerance for .2 s Duration to $\pm 4/\text{Pulse}$.

Page 5-12 Table 5-4

CHANGE: Tolerance for 200 ms Delay to $\pm 4/200$ ms.

CORRECT: line one of footnote ¹ to read:

To check or adjust 20 ns delay, switch the PULSE MODE between UNDLY'D and ----- etc.

ELECTRICAL PARTS LIST AND SCHEMATIC CORRECTIONS

CHANGE TO:

C13	281-0613-00	10 pF	Cer	200 V	5%
C51	283-0680-00	330 pF		300 V	1%
C163	283-0651-00	430 pF		500 V Mica	1%
Q194	151-0198-00	Silicon		MPS918	
Q196	151-0198-00	Silicon		MPS918	
R13	315-0681-00	680 Ω	1/4 W		5%
R49	315-0390-00	39 Ω	1/4 W		5%
R195	301-0152-00	1.5 k Ω	1/2 W		5%
R265	322-0218-00	1.82 k Ω	1/4 W		1%
R267	322-0216-00	1.74 k Ω	1/4 W		1%
R365	322-0216-00	1.74 k Ω	1/4 W		1%
R367	322-0218-00	1.82 k Ω	1/4 W		1%

ADD:

C194	281-0500-00	2.2 pF		500 V	± 0.5 pF
C238	281-0513-00	27 pF		500 V	± 5.4 pF
C338	281-0513-00	27 pF		500 V	± 5.4 pF
R210	315-0332-00	3.3 k Ω	1/4 W		5%
R238	315-0270-00	27 Ω	1/4 W		5%
R310	315-0242-00	2.4 k Ω	1/4 W		5%
R338	315-0270-00	27 Ω	1/4 W		5%

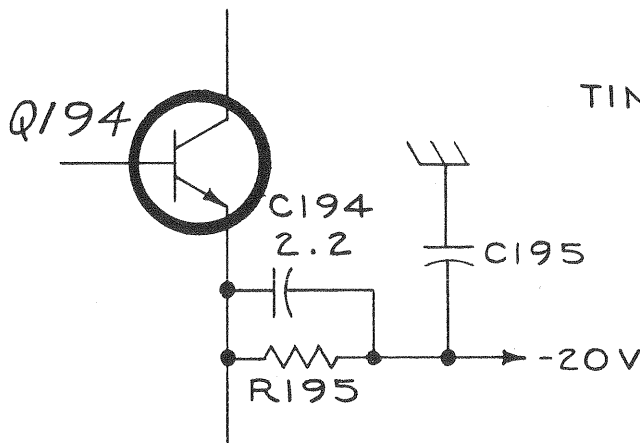

PARTIAL-TIMING CIRCUITS



